

ZPT

TYPE 125

7

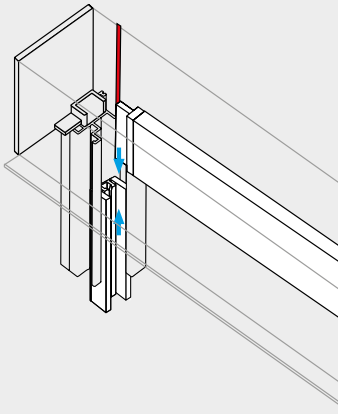
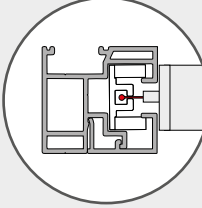
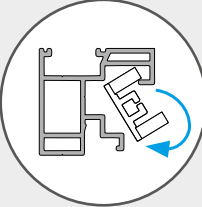

8

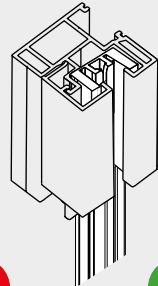
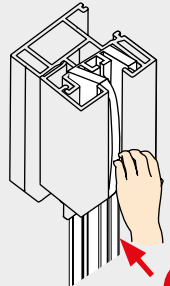
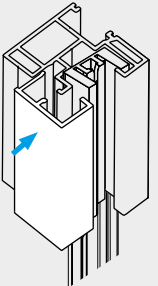

9

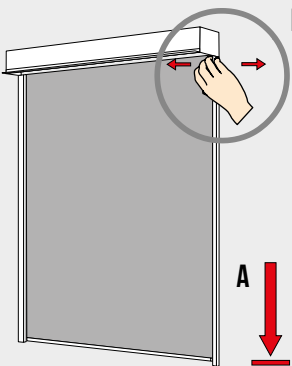

B

A max

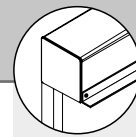
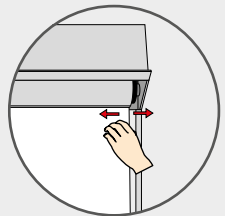

ZPT

TYPE 125

9

centering

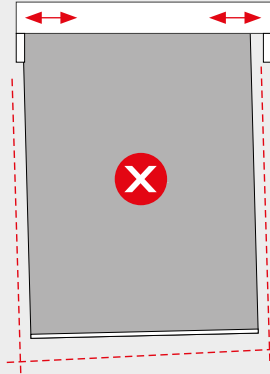
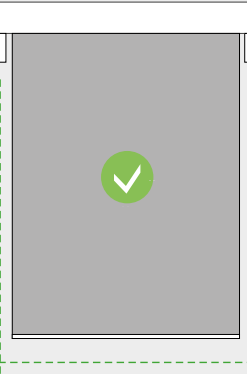

10

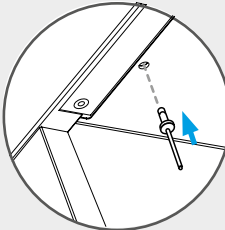
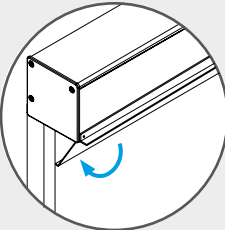

11

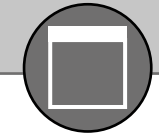
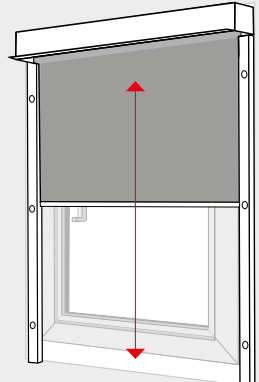

ZPT

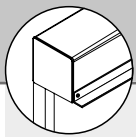

ZPT

TYPE 125

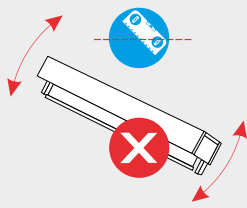
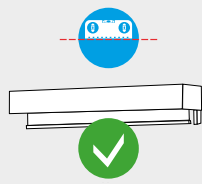

1

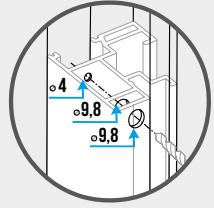
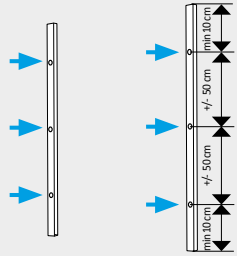

2

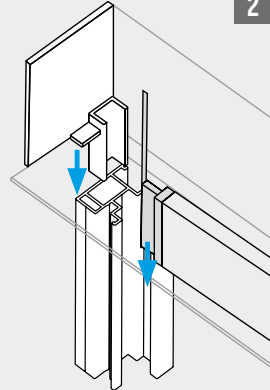
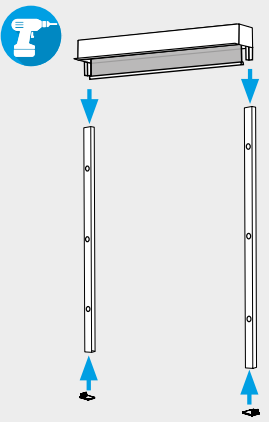

3

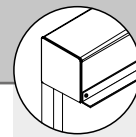
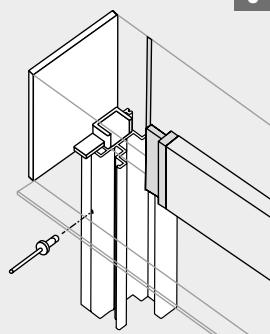
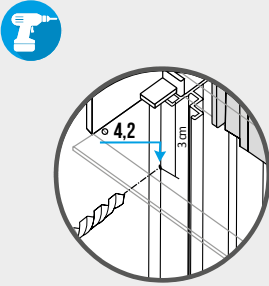

ZPT

TYPE 125

4

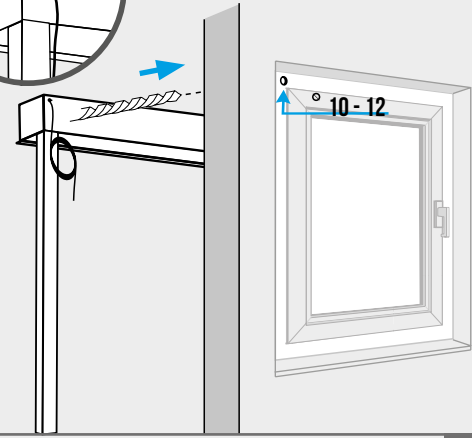
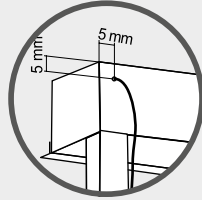

5

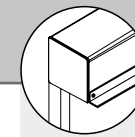
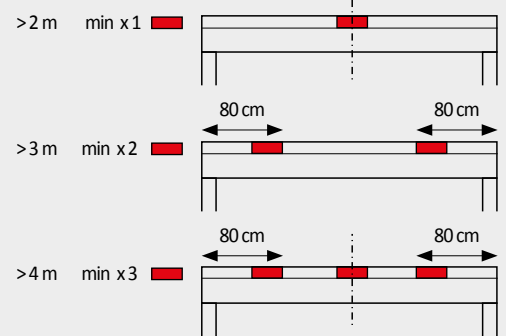
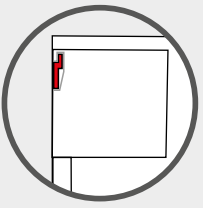
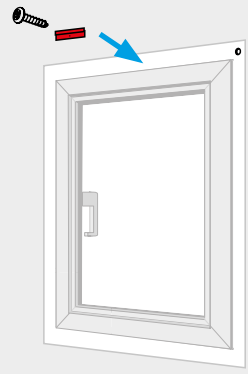
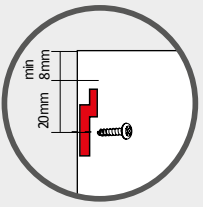

ZPT

TYPE 125

6

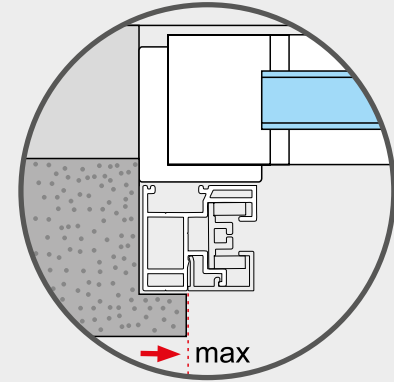
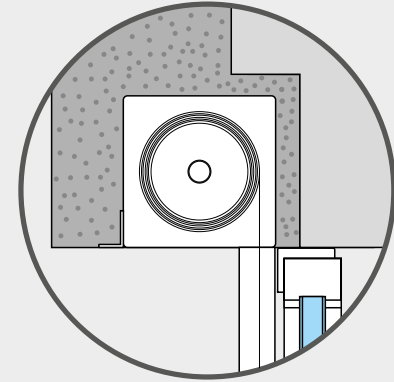

X1 = X2
W1 = W2

