

KATALOG TECHNICZNY

Profile roletowe

KOD	OZNACZENIE KOLORU																																												
	01	02	03	04	05	06	07	08	09	11	12	13	15	16	17	18	19	20	22	23	24	26	28	30	31	33	34	35	36	37	38	39	40	41	42	43	44	49	52	71	75	79			
PA39	std	std	std	std	std	ldr	ldr	std	std	ex	ex	ex	std	std	ex	ex	ex	std	std	std	ldr	ldr	ldr	ldr	std	ex	ex	ex	ldr	ex	ex	ex			ex		ldr	ldr		std	ldr				
PA43	std	std	std	std	std	ldr		std	std			std	std					std	std	std	ldr	ldr	ldr	ldr	std	ex	ex	ex	ldr	ex							ldr	ldr							
PA52	std	std	std		std	ldr		std	std			ex	std						std	std			ldr	ldr	std		ex		ldr	ex		ex	ex			ex		ldr	ex	std					
PA55	std	std	std		std	ldr	ldr	std	std				ex	ex	ex	ex			std	std				ldr			ex																		
PE41		std	std		std			std	std																																				
PE55		std	std		std			std	std																																				
PA77	std	std	std		std	ldr		std	std										std	std			ldr	ldr																		ex			
PER77		std	std		std			std	std																																				
LA32																				std																									

*std – standard

*ldr – drewnopodobny (lakier)

*ex – extra

PA39



Wysokość profilu 39mm
 Grubość profilu 9mm
 Ilość listew na 1 m wysokości 25,6szt.
 Ciężar 2,8kg
 Maksymalna powierzchnia 6m²

PA43

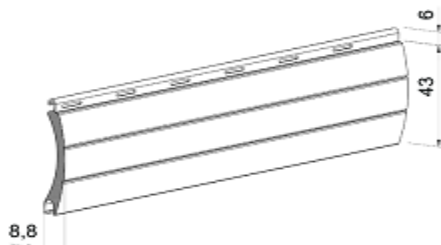

Wysokość profilu 43mm
 Grubość profilu 8,8mm
 Ilość listew na 1 m wysokości 23,2szt.
 Ciężar 2,6kg
 Maksymalna powierzchnia 9m²

PA52

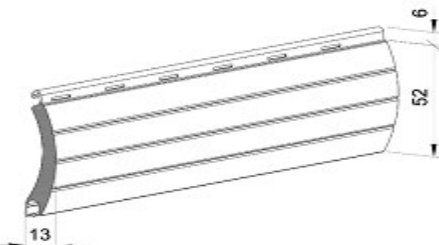

Wysokość profilu 52mm
 Grubość profilu 13mm
 Ilość listew na 1 m wysokości 19szt.
 Ciężar 3,0kg
 Maksymalna powierzchnia 8m²

PA55

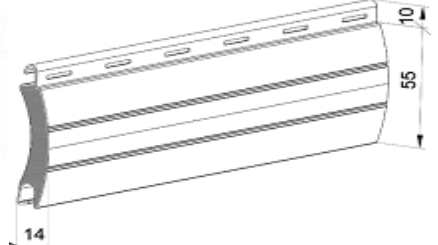

Wysokość profilu 55mm
 Grubość profilu 14mm
 Ilość listew na 1 m wysokości 18szt.
 Ciężar 3,4kg
 Maksymalna powierzchnia 9,5m²

PER77

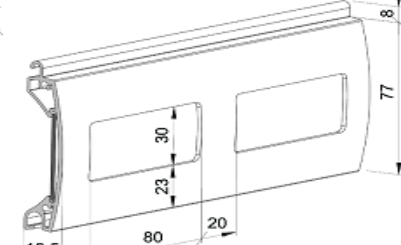

Wysokość profilu 77mm
 Grubość profilu 18,5mm
 Ciężar 12kg

PE41

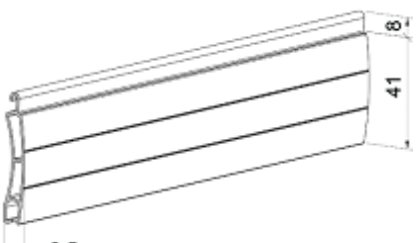

Wysokość profilu 41mm
 Grubość profilu 8,5mm
 Ilość listew na 1 m wysokości 24szt.
 Ciężar 7,3kg
 Maksymalna powierzchnia 8,5m²

PE55

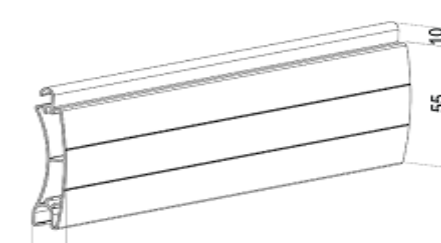

Wysokość profilu 55mm
 Grubość profilu 14mm
 Ilość listew na 1 m wysokości 18szt.
 Ciężar 8,7kg
 Maksymalna powierzchnia 15m²

PA77

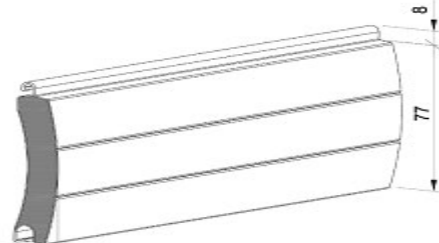

Wysokość profilu 77mm
 Grubość profilu 18,5mm
 Ilość listew na 1 m wysokości 13szt.
 Ciężar 4,8kg
 Maksymalna powierzchnia 15m²

LA32

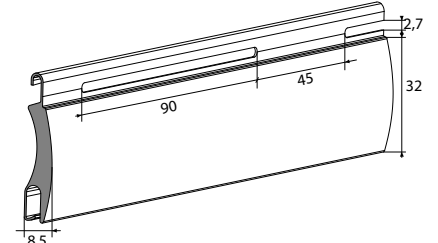

Wysokość profilu 32mm
 Grubość profilu 8,5mm
 Ilość listew na 1 m wysokości 31,2szt.
 Ciężar 3,5kg
 Maksymalna powierzchnia 6m²

Skrzynki roletowe SK45

KOD	OZNACZENIE KOLORU															
	01	02	03	05	08	09	15	22	23	26	28	30	30R	34	52R	53R
SK45/125		std	std		std	std		std	std							
SK45/137	std	std	std	std	std	std	std	std	std	ldr	ldr	ldr	odr	ex	odr	odr
SK45/165	std	std	std	std	std	std	std	std	std	ldr	ldr	ldr	odr	ex	odr	odr
SK45/180	std	std	std	std	std	std	std	std	std	ldr	ldr	ldr	odr	ex	odr	odr
SK45/205	std	std	std	std	std	std	std		std		ldr	ldr	odr	ex	odr	odr
SK45/250	std	std	std		std	std			std							
SK45/300	std	std	std		std	std			std		ldr	ldr				
SK45/350	std	std	std		std	std			std							
SK45/MKT/165	std	std	std	std	std	std	std	std	std	ldr	ldr	ldr	odr			
SK45/MKT/180	std	std	std	std	std	std	std	std	std	ldr	ldr	ldr	odr			
SK45/MKT/205	std	std	std	std	std	std	std		std		ldr	ldr	odr			

*std – standard *ldr – drewnopodobny (lakier) *odr - drewnopodobny (okleina) *ex – extra

Wymiary skrzynek				
	A (mm)	B (mm)	C (mm)	D (mm)
SK45/125	128	125	115	90
SK45/137	139	137	127	104
SK45/165	167	165	155	130
SK45/180	183	180	170	144
SK45/205	207	205	195	170
SK45/250	255	250	240	208
SK45/300	306	300	290	250
SK45/350	360	50	350	305
SK45/MKT/165	167	165	155	119
SK45/MKT/180	183	180	170	133
SK45/MKT/205	207	205	195	158

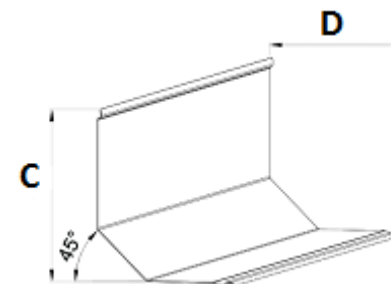
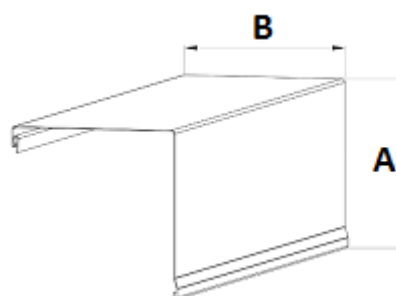

Skrzynki roletowe SKP Półowal

KOD	OZNACZENIE KOLORU					
	01	02	03	08	09	23
SKP/137	std	std	std	std	std	std
SKP/165	std	std	std	std	std	std
SKP/180	std	std	std	std	std	std
SKP/205	std	std	std	std	std	std
SKP/MKT/165	std	std	std	std	std	
SKP/MKT/180	std	std	std	std	std	

*std – standard

Wymiary skrzynek				
	A (mm)	B (mm)	C (mm)	D (mm)
SKP/137	139	137	129	105
SKP/165	167	165	157	128
SKP/180	183	180	172	143
SKP/205	207	205	197	160
SKP/MKT/165	167	165	157	121
SKP/MKT/180	183	180	172	136

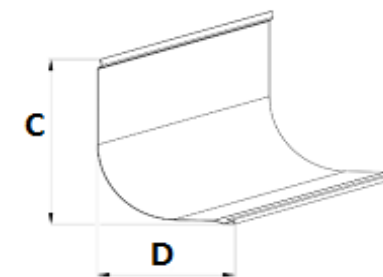
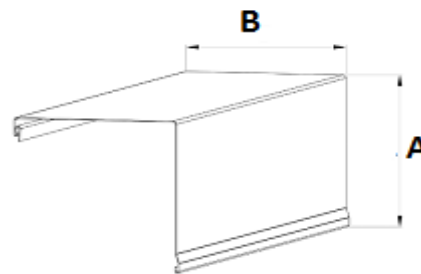

Skrzynki roletowe SKO-P Owal

KOD	OZNACZENIE KOLORU								
	01	02	03	08	09	15	22	23	34
SKO-P/137	std	std	std	std	std	std	std	std	ex
SKO-P/165	std	std	std	std	std	std	std	std	ex
SKO-P/180	std	std	std	std	std	std	std	std	ex
SKO-P/205	std	std	std	std	std	std		std	ex
SKO-P/MKT/165	std	std	std	std	std				
SKO-P/MKT/180	std	std	std	std	std				

*std – standard

*ex – extra

Wymiary skrzynek				
	A (mm)	B (mm)	C (mm)	D (mm)
SKO-P/137	141	131	113	111
SKO-P/165	168	157	133	134
SKO-P/180	184	171	145	150
SKO-P/205	206	195	163	167
SKO-P/MKT/165	184	171	134	123
SKO-P/MKT/180	206	195	145	143

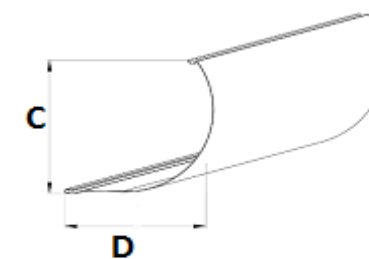
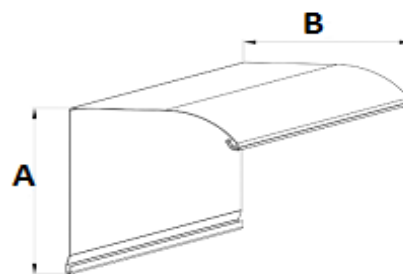

Skrzynki roletowe SP-E Integro

(pokrywa rewizyjna, wspornik)

KOD	OZNACZENIE KOLORU																			
	01	02	03	08	09	20	22	23	23R	28R	30R	40S	41S	42S	43S	44S	49	52R	53R	79R
SP-E/137	ex	std	std	std	std	ex	std	std	odr	odr	odr	ex	ex	ex	ex	ex	odr	odr	odr	odr
SP-E/165	ex	std	std	std	std	ex	std	std	odr	odr	odr	ex	ex	ex	ex	ex	odr	odr	odr	odr
SP-E/180	ex	std	std	std	std	ex	std	std	odr	odr	odr	ex	ex	ex	ex	ex	odr	odr	odr	odr
SP-E/205	ex	std	std	std	std	ex	std	std		odr	odr	ex	ex	ex	ex	ex	odr	odr	odr	
SP-E/MKT/205	ex	std	std	std	std		std	std		odr	odr	ex	ex	ex	ex	ex	odr	odr	odr	

*std – standard

*odr – drewnopodobny (okleina)

*ex – extra

Wymiary skrzynek				
KOD	A (mm)	B (mm)	C (mm)	D (mm)
SP-E/137	137	137	98	111
SP-E/165	165	164	126	139
SP-E/180	180	180	142	150
SP-E/205	205	205	167	171
SP-E/MKT/205	205	205	167	165

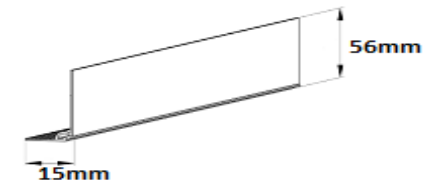
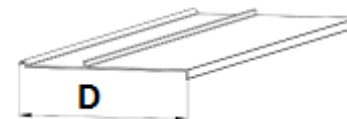
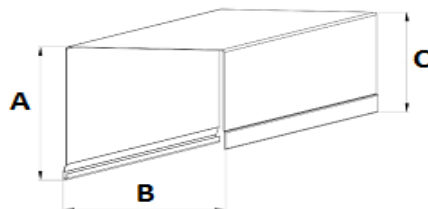

S – kolory specjalne na zamówienie

Skrzynki roletowe SKT Opoterm

KOD	KOLOR	NAZWA FOLII	KOD FOLII
02	Biały		
08	Brąz		
23R	Szary antracyt	anthrazitgrau / anthracite grey	LG KDB74
26R	Mahoń	mahagoni / mahogany	LG UR602
280R	Orzech	nuss / nut	9.21788007
300R	Złoty dąb	goldeiche / golden oak	9.2178001
52R	Winchester	winchester / winchester	9.0049240
53R	Dąb ciemny	dunkel eiche / dark oak	9.2052089

Wymiary skrzynek		
KOD	A (mm)	B (mm)
SKT 230/170	230	170
SKT 230/210	230	210
SKT 255/240	255	240

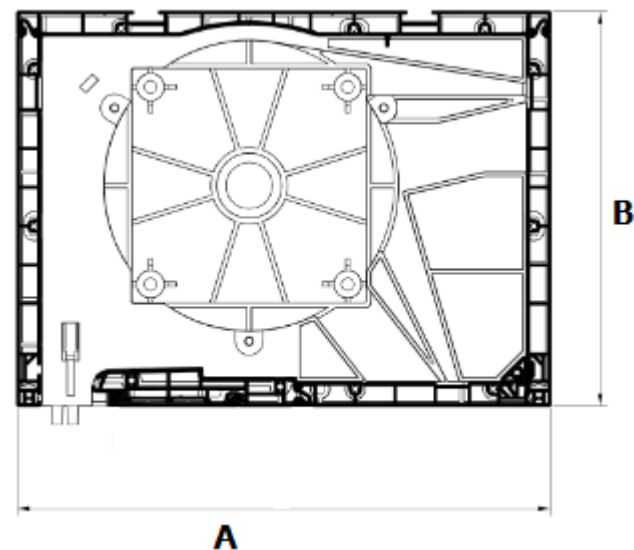

Boki skrzynek alu

KOD	OZNACZENIE KOLORU																							
	01	02	03	05	08	09	15	22	23	26R	28	28R	30	30R	32	34	40S	41S	42S	43S	44S	52R	53R	
BS45/125		std	std		std	std		std	std															
BS45/137	ex	std	std	std	std	std	std	std	std	odr	ldr	odr	ldr	odr	std	ex						odr	odr	
BS45/165	ex	std	std	std	std	std	std	std	std	odr	ldr	odr	ldr	odr	std	ex						odr	odr	
BS45/180	ex	std	std	std	std	std	std	std	std	odr	ldr	odr	ldr	odr	std	ex						odr	odr	
BS45/205	ex	std	std	std	std	std	std		std	odr	ldr	odr	ldr	odr	std	ex						odr	odr	
BS45/250	ex	std	std		std	std			std															
BS45/300	ex	std	std		std	std			std		ldr		ldr											
BS45/K/350	ex	std	std		std	std			std															
BSP/137	ex	std	std		std	std			std															
BSP/165	ex	std	std		std	std			std															
BSP/180	ex	std	std		std	std			std															
BSP/205	ex	std	std		std	std			std															
BSO/137	ex	std	std		std	std	std	std	std							ex	ex	ex	ex	ex	ex			
BSO/165	ex	std	std		std	std	std	std	std							ex	ex	ex	ex	ex	ex			
BSO/180	ex	std	std		std	std	std	std	std							ex	ex	ex	ex	ex	ex			
BSO/205	ex	std	std		std	std	std	std	std							ex	ex	ex	ex	ex	ex			
BSO/250		std																						
BSO/300		std																						

*std – standard

*ldr – drewnopodobny (lakier)

*odr – drewnopodobny (okleina)

*ex – extra

Wymiary pokryw

A
(mm)

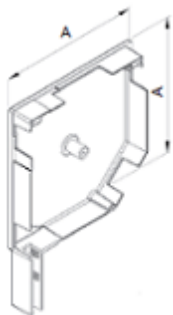

BS45/125	126
BS45/137	140
BS45/165	168
BS45/180	183
BS45/205	208
BS45/250	252
BS45/300	302

Wymiary pokryw

A
(mm)

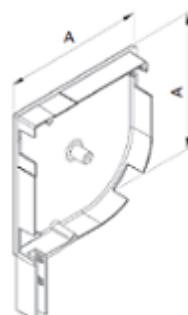

BSP/137	137
BSP/165	166
BSP/180	181
BSP/205	206

Wymiary pokryw

A
(mm)

B
(mm)

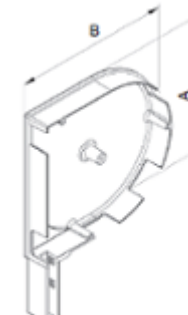

BSO/137	142	147
BSO/165	170	175
BSO/180	185	190
BSO/205	212	217
BSO/250	252	262
BSO/300	302	312

S – kolor specjalny na zamówienie

Kolory boków 28R, 30R, 52R, 53R – podlegają indywidualnej wycenie.

Listwy dolne

KOD	OZNACZENIE KOLORU																									
	01	02	03	05	08	09	15	20	22	23	23R	26R	28	28R	30	30R	34	40S	41S	42S	43S	44S	49	52R	53R	79R
LDG-E	ex	std	std	std	std	std	std	std	std	std	odr	odr	ldr	odr	ldr	odr	ex	ex	ex	ex	ex	ex	odr	odr	odr	odr
LDG52	ex	std	std	std	std	std			std	std				ldr		ex	ex	ex	ex	ex	ex					
LDG52/OPT	ex	std	std	std	std	std			std					ldr			ex	ex	ex	ex	ex					
LDG/S	ex	std	std	std	std	std			std	std					odr	ex										
LDG/D	ex	std	std	std	std	std			std	std			ldr		ldr		ex	ex	ex	ex	ex					
LDG55/W		std	std	std	std	std											ex	ex	ex	ex	ex					
LDSM MKT	ex	std	std	std	std	std	std		std	std		odr	ldr	odr	ldr	odr										

KOD	OZNACZENIE KOLORU	
	280R	300R
LDG-E	odr	odr
LDSM MKT	odr	odr

*std – standard

*ldr – drewnopodobny (lakier)

*odr – drewnopodobny (okleina)

*ex – extra

LDG-E

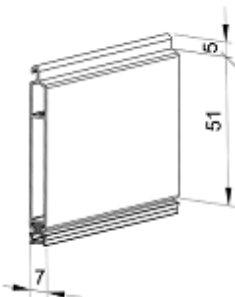

LDG52

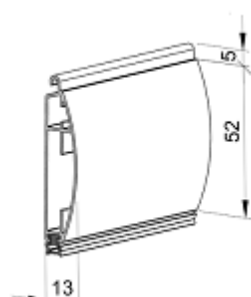

LDG52/OPT

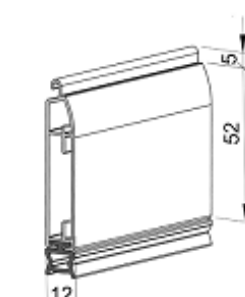

LDG55/W

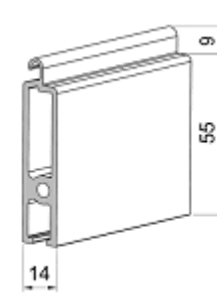

LDG/S

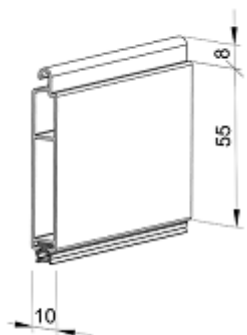

LDG/D



LDSM MKT

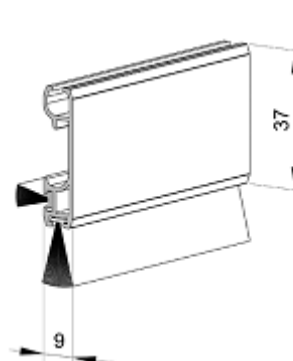

S – kolor specjalny na zamówienie

Prowadnice aluminiowe

KOD	OZNACZENIE KOLORU																								
	01	02	03	05	08	09	15	20	22	23	23R	26R	28	28R	30	30R	34	40S	41S	42S	43S	44S	52R	53R	79R
prowadnice pojedyncze																									
PP45		std	std		std	std				std															
PU45		std	std	std	std	std				std	std														
PP53	ex	std	std	std	std	std	std	std	std	std	odr	odr	ldr	odr	ldr	odr	ex	ex	ex	ex	ex	ex	odr	odr	odr
PK53	ex	std	std	std	std	std	std	std	std	std	odr	odr	ldr	odr	ldr	odr		ex	ex	ex	ex	ex	odr	odr	
PP53/ODS	ex	std	std	std	std	std				std	std														
PP53/ODS/20	ex	std	std	std	std	std	std			std	std														
PPMO53	ex	std			std	std		std	std	std			ldr		ldr										
PPDO53	ex	std	std	std	std	std	std	std	std	std	odr	odr	ldr	odr	ldr	odr		ex	ex	ex	ex	ex	odr	odr	odr
PP68	ex	std	std	std	std	std		std	std	std		odr	odr	ldr	odr	ldr									
PPW66		std	std	std	std	std												ex	ex	ex	ex	ex			
PP66	ex	std	std	std	std	std									ldr	odr		ex	ex	ex	ex	ex	ex		
PP75	ex	std	std		std	std			std	std							ex	ex	ex	ex	ex	ex			
PP89	ex	std	std	std	std	std			std	std			ldr		ldr			ex	ex	ex	ex	ex			
PP110	ex	std	std	std	std	std																			
PPW80		std	std	std	std	std												ex	ex	ex	ex	ex			
PPW90		std	std		std	std												ex	ex	ex	ex	ex			
prowadnice podwójne																									
PPD79	ex	std	std	std	std	std		ex	std	std		odr	ldr	odr	ldr	odr		ex	ex	ex	ex	ex	odr	odr	
PPD79/ODS	ex	std	std	std	std	std				std															
PPD79/ODS/20		std			std	std				std															
PPDO79	ex	std	std	std	std	std				std															
PPDMO79	ex	std			std	std		std	std	std			ldr		ldr										
nakładki																									
N/PPDO	ex	std	std		std	std			std	std								ex	ex	ex	ex	ex			
N/PP66	ex	std	std		std	std												ex	ex	ex	ex	ex			
N/PPD79	ex	std	std		std	std			std									ex	ex	ex	ex	ex			
dystans																									
D/PP	ex	std	std	std	std	std			std	std		odr		odr		odr		ex	ex	ex	ex	ex			
prowadnice aluminiowe do systemu OPOTERM																									
PPDAMW60/12		std			std					std															
PPDAMW-P60/12		std			std					std															
PPMO60/12					std	std	std			std		ldr		ldr											
PPMO60/17					std	std	std			std		ldr		ldr											
PPDA60/12					std																				
PPDA60/17					std																				

OZNACZENIE KOLORU		
KOD	280R	300R
PPDAMW60/12	odr	odr
PPDAMW-P60/12	odr	odr
PPDA60/12	odr	odr
PPDA60/17	odr	odr

*std – standard

*ldr – drewnopodobny (lakier)

*odr – drewnopodobny (okleina)

*ex – extra

S – kolor specjalny na zamówienie

PP53

do profilu PA39, PA43

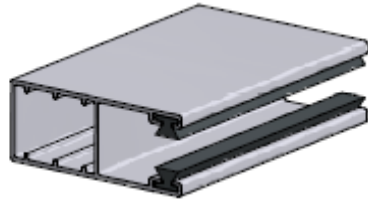
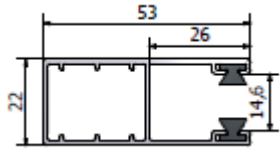

PK53

do profilu PA39, PA43

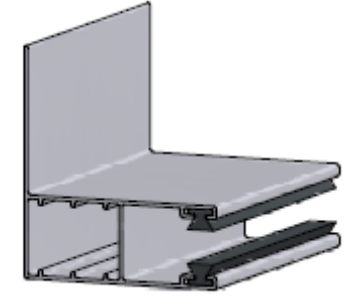
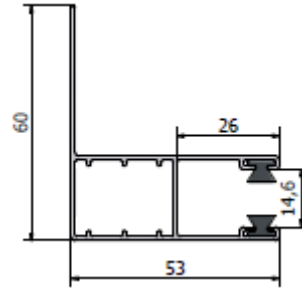

PP53/ODS

do profilu PA39, PA43

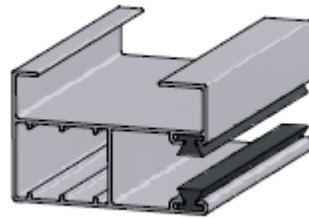
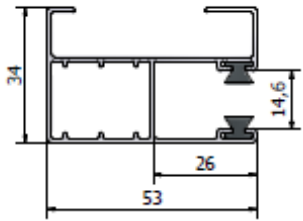

PPM053

do profilu PA39, PA43

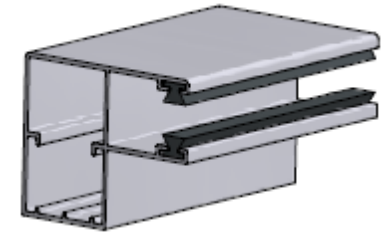
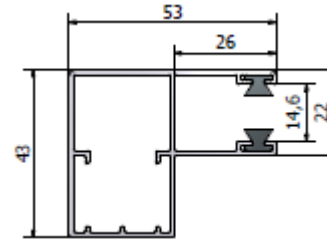

PPD053

do profilu PA39, PA43

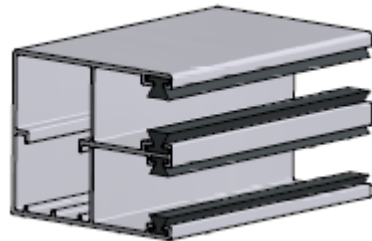
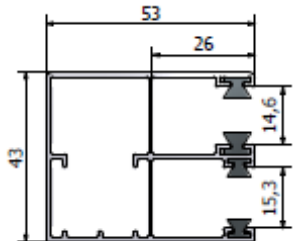

PP68

do profilu PA39, PA43

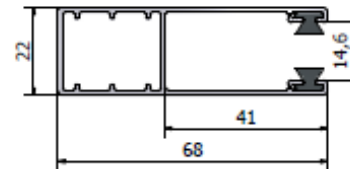

PPW66
do profilu PE41

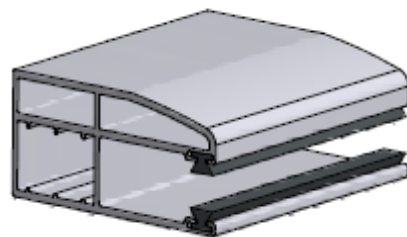
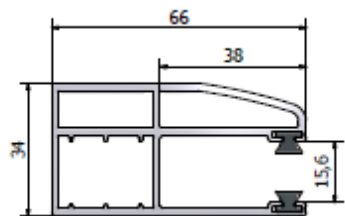

PP66
do profilu PA52, PA55

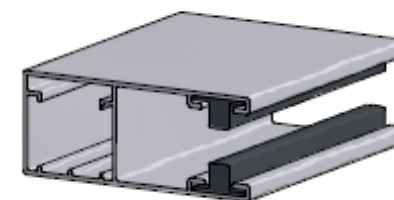
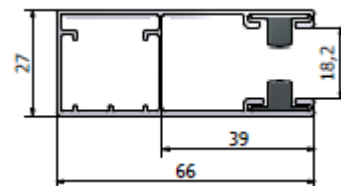

PP75
do profilu PA52, PA55

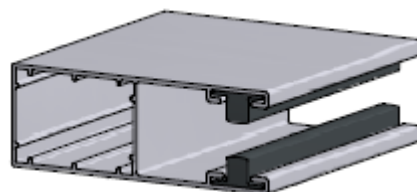
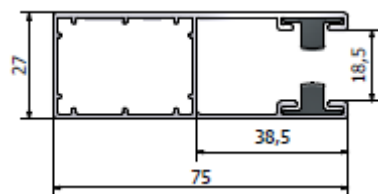

PP89
do profilu PA77

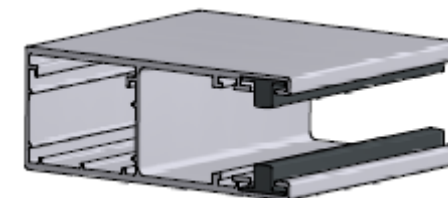
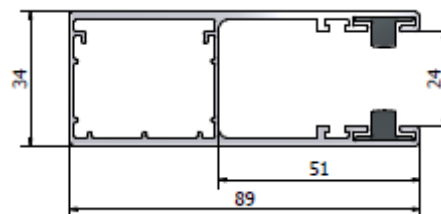

PP110
do profilu PA77

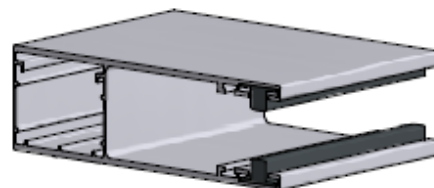
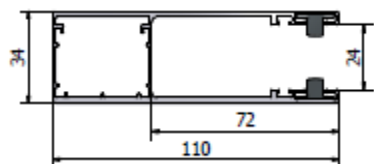

PPW80
do profilu PE55

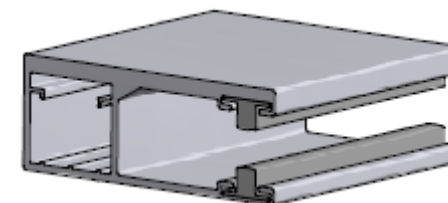
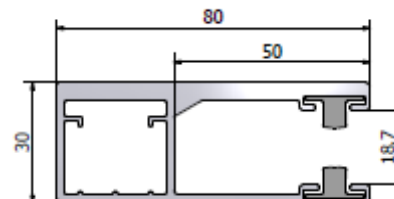

PPW90
do profilu PE55

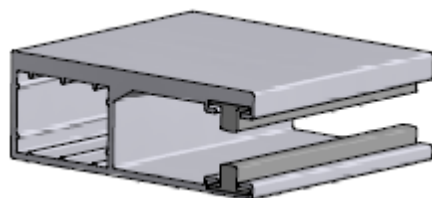
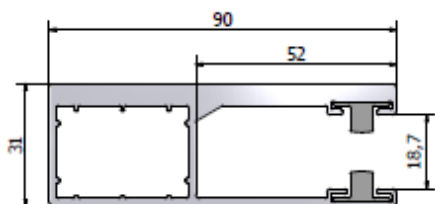

PPD79
do profilu PA39, PA43

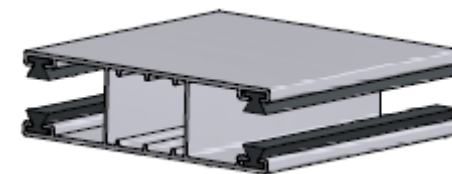
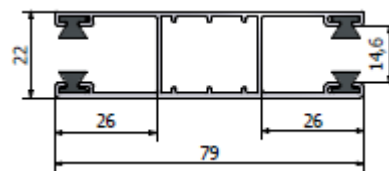

PPD79/ODS
do profilu PA39, PA43

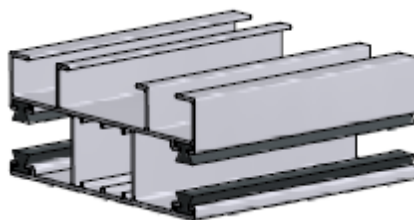
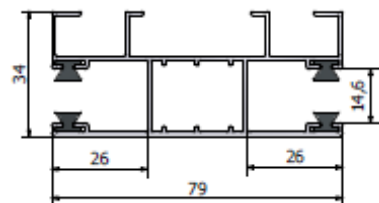

N/PPDO
stosowane z PP53, PP53/ODS, PK53, PPDO53,
PPMO53 + płytka PZO

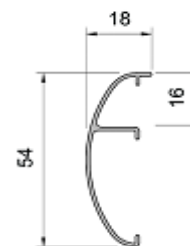

N/PP66
stosowane z PP66 + płytka PZO

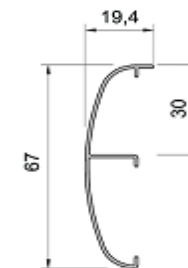

N/PPD79
stosowane z PPD79, PPD79/ODS + płytka PZO

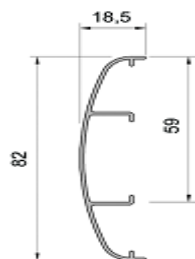

D/PP
stosowane z PP53, PK53, PPDO53 + płytka PZO

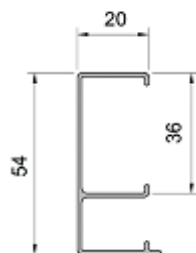

PP45

do profilu PA39, PA43

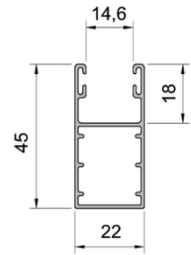

PU45

do profilu PA52, PA55

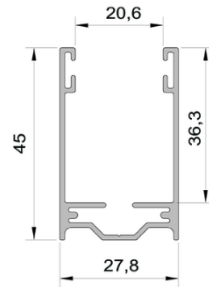

PP53/ODS/20

do profilu PA39, PA43

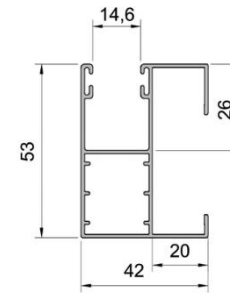

PPDO79

do profilu PA39, PA43

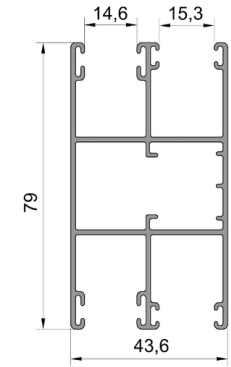

PPDMO79

do profilu PA39, PA43

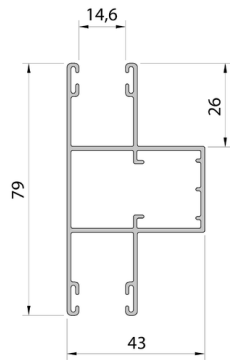

PPD79/ODS

do profilu PA39, PA43

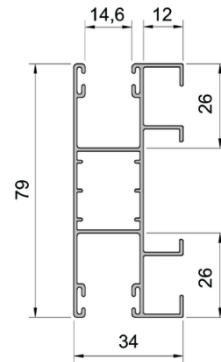

PPD79/ODS/20

do profilu PA39, PA43

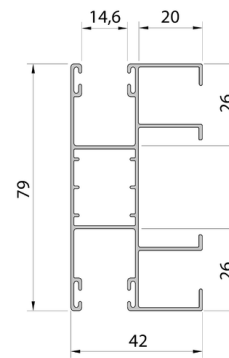

PPDA60/12

do profilu PA39, PA43

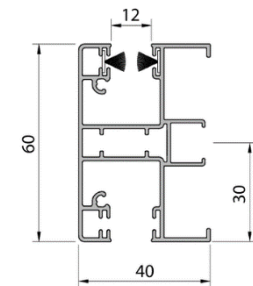

PPDA60/17

do profilu PA52

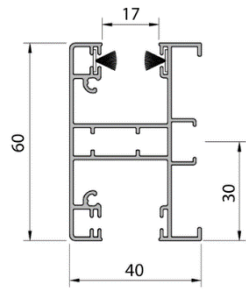

PPDAMW60/12

do profilu PA39, PA43

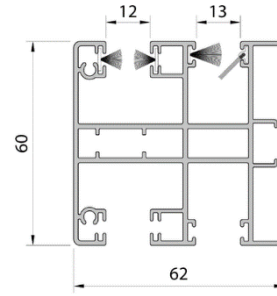

PPDAMW-P60/12

do profilu PA39, PA43

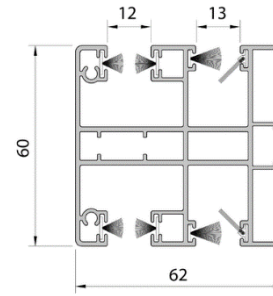

PPMO60/12

do profilu PA39, PA43

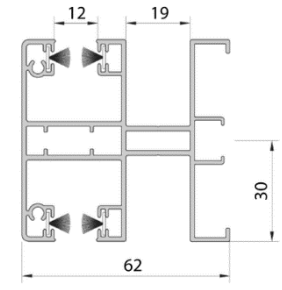

PPMO60/17

do profilu PA52

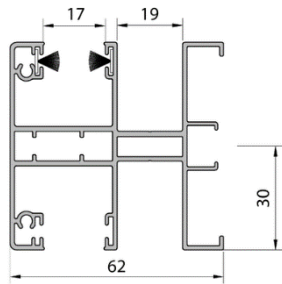

Prowadnice PCV

KOD	KOLOR	NAZWA FOLII	KOD FOLII
02	Biały		
08	Brąz		
23R	Szary antracyt	anthrazitgrau / anthracite grey	LG KDB74
26R	Mahoń	mahagoni / mahogany	LG UR602
280R	Orzech	nuss / nut	9.21788007
300R	Złoty dąb	goldeiche / golden oak	9.2178001
52R	Winchester	winchester / winchester	9.0049240
53R	Dąb ciemny	dunkel eiche / dark oak	9.2052089

PPD60/12

do profilu PA39, PA43

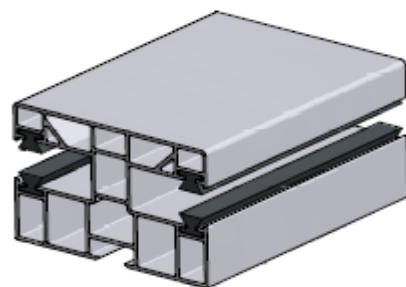
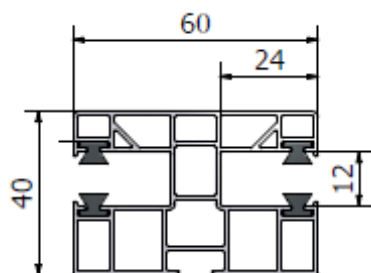

PPD60/17

do profilu PA52

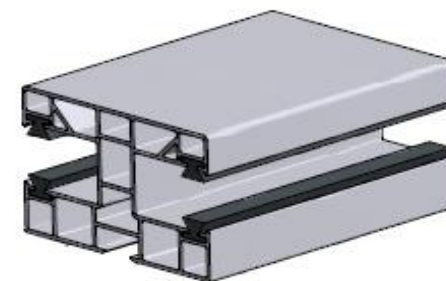
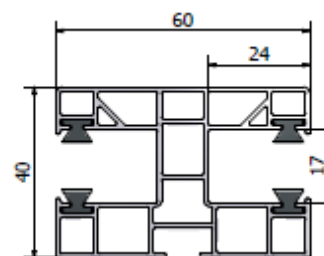

PPDM60/12

do profilu PA39, PA43

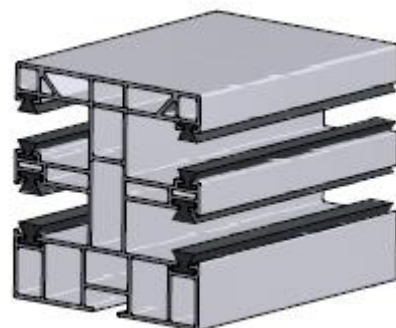
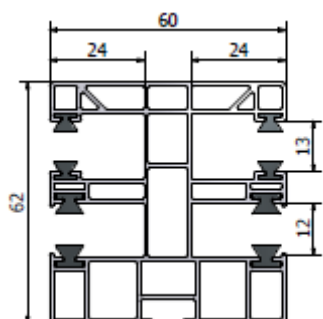

PPDM60/17

do profilu PA52

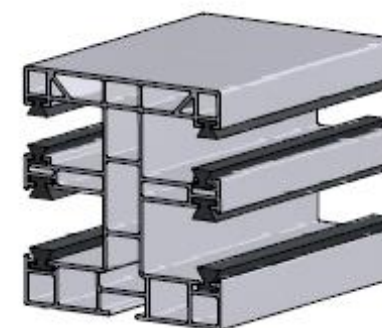
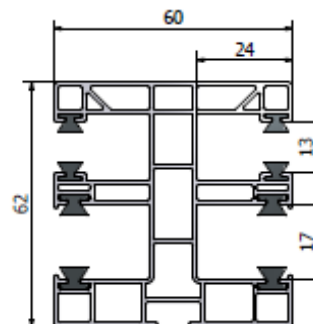

PPDMW60/12

do profilu PA39, PA43

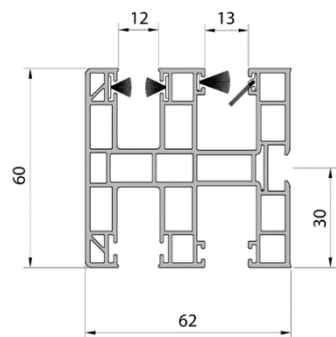

PPDMW60/17

do profilu PA52

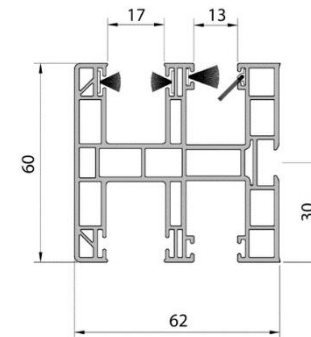

PPDMW-P60/12

do profilu PA39, PA43

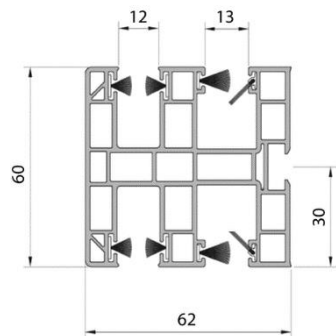

PPDMW-P60/17

do profilu PA52

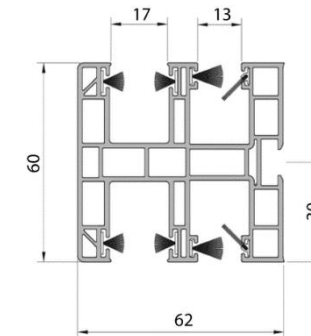

Nawojowość żaluzji zwijanych

NAWOJOWOŚĆ DLA LA32 W SYSTEMIE HERA A45				
SKRZYŃKA	SW40 + WB	SW40 + PZ45	SW60 + WB	SW60 + PZ68
HERA A45 - 125	960	960	800	600
HERA A45 - 137	1300	1280	980	1000
HERA A45 - 165	1650	1920	1780	1650
HERA A45 - 180	2300	2300	2240	2080
HERA A45 - 205	2700	2700	2700	2700

NAWOJOWOŚĆ DLA LA32 W SYSTEMIE INTEGRO SP-E				
SKRZYŃKA	SW40 + WB	SW40 + PZ45	SW60 + WB	SW60 + PZ68
SP-E - 137	1300	1280	980	1110
SP-E - 165	1650	1650	1780	1650
SP-E - 180	2300	2300	2240	2080
SP-E - 205	2700	2700	2700	2700

NAWOJOWOŚĆ DLA LA32 W SYSTEMIE OPOTERM SKT				
SKRZYŃKA	SW40 + WB	SW40 + PZ45	SW60 + WB	SW60 + PZ68
SKT - 170	1320	1360	1320	1200
SKT - 210	2440	2520	2350	2390
SKT - 240	2700	2700	2700	2700

NAWOJOWOŚĆ DLA LA39 W SYSTEMIE HERA P90				
SKRZYŃKA	SW40 + WB	SW40 + PZ45	SW60 + WB	SW60 + PZ68
HERA P90 - 137	1340	1340	1210	1210
HERA P90 - 150	1790	1770	1590	1500
HERA P90 - 165	2230	2290	2050	2050
HERA P90 - 180	2950	2980	2790	2590
HERA P90 - 205	3800	3940	3460	3540

Nawojowość żaluzji zwijanych

Profil PA39

Maksymalna wysokość rolety wraz ze skrzynką (mm)						
	SW40	SW40 + PZ/45	SW40 + PW/40	SW60	SW60 + PZ/68	SW60 + PW/60
SK/125	1240	1280	-	-	-	-
SK/SKP/SP-E/137	1560	1600	-	1440	1210	-
SK/SKP/SP-E/165	2390	2470	2030	2280	2120	1450
SK/SKP/SP-E/180	2950	3020	2520	2790	2630	1930
SK/SKP/SP-E/205	4320	4210	3480	4050	3780	3400

Maksymalna wysokość rolety wraz ze skrzynką (mm)						
	SW40	SW40 + PZ/45	SW40 + PW/40	SW60	SW60 + PZ/68	SW60 + PW/60
SKO-P/137	1560	1600	-	1410	1250	-
SKO-P/165	2430	2510	2080	2320	2160	1450
SKO-P/180	3260	3100	2910	3060	2640	2330
SKO-P/205	4370	4250	3950	4130	3820	3410

Maksymalna wysokość rolety wraz ze skrzynką (mm)						
	SW40	SW40 + PZ/45	SW40 + PW/40	SW60	SW60 + PZ/68	SW60 + PW/60
SKT/230/170	1890	1690	1220	1730	1570	980
SKT/230/210	3230	3310	2860	3270	3040	2310
SKT/255/240	4460	4770	3940	4460	4420	4020

Profil PA39 + MKT

Maksymalna wysokość rolety wraz ze skrzynką (mm)						
	SW40	SW40 + PZ/45	SW40 + PW/40	SW60	SW60 + PZ/68	SW60 + PW/60
SK/SKP/SP-E/165	1730	1690	1330	1600	1650	1100
SK/SKP/SP-E/180	2440	2240	1780	2360	1850	1540
SK/SKP/SP-E/205	2500	2500	2500	2500	2500	2500

Maksymalna wysokość rolety wraz ze skrzynką (mm)						
	SW40	SW40 + PZ/45	SW40 + PW/40	SW60	SW60 + PZ/68	SW60 + PW/60
SKO-P/165	1650	1690	1300	1540	1340	790
SKO-P/180	2440	2480	2050	2280	2130	1550
SKO-P/205	2500	2500	2500	2500	2500	2500

Maksymalna wysokość rolety wraz ze skrzynką (mm)						
	SW40	SW40 + PZ/45	SW40 + PW/40	SW60	SW60 + PZ/68	SW60 + PW/60
SKT/230/170	1600	1460	-	1220	1260	-
SKT/230/210	2490	2220	-	1980	1870	-
SKT/255/240	2500	2500	-	2500	2500	-

Maksymalna wysokość rolety wraz ze skrzynką (mm)						
	SW40	SW40 + PZ/45	SW40 + PW/40	SW60	SW60 + PZ/68	SW60 + PW/60
SKT NOVA/230/170	1490	1550	870	1100	1140	630
SKT NOVA/230/210	2450	2410	1900	2170	2020	1350
SKT NOVA/255/240	2600	2600	2600	2600	2600	2600

Profil PA43

Maksymalna wysokość rolety wraz ze skrzynką (mm)						
	SW40	SW40 + PZ/45	SW40 + PW/40	SW60	SW60 + PZ/68	SW60 + PW/60
SK/125	-	970	-	-	-	-
SK/SKP/SP-E/137	-	1410	-	1150	930	-
SK/SKP/SP-E/165	-	2500	1620	2320	2110	1800
SK/SKP/SP-E/180	-	2980	2460	2800	2590	2280
SK/SKP/SP-E/205	-	4020	3900	3850	3630	3340

Maksymalna wysokość rolety wraz ze skrzynką (mm)						
	SW40	SW40 + PZ/45	SW40 + PW/40	SW60	SW60 + PZ/68	SW60 + PW/60
SKO-P/137	-	1410	-	1150	980	-
SKO-P/165	-	2500	1630	2320	2070	1800
SKO-P/180	-	2980	2460	2800	2590	2330
SKO-P/205	-	4020	3910	3980	3640	3520

Maksymalna wysokość rolety wraz ze skrzynką (mm)						
	SW40	SW40 + PZ/45	SW40 + PW/40	SW60	SW60 + PZ/68	SW60 + PW/60
SKT/230/170	-	1720	1460	1460	1590	1240
SKT/230/210	-	3120	3000	3250	3080	2440
SKT/255/240	-	4680	4110	4420	4210	3930

Profil PA43 + MKT

Maksymalna wysokość rolety wraz ze skrzynką (mm)						
	SW40	SW40 + PZ/45	SW40 + PW/40	SW60	SW60 + PZ/68	SW60 + PW/60
SK/SKP/SP-E/165	-	1600	1190	1510	1330	1020
SK/SKP/SP-E/180	-	2460	1810	1900	2120	1600
SK/SKP/SP-E/205	-	2500	2500	2500	2500	2500

Maksymalna wysokość rolety wraz ze skrzynką (mm)						
	SW40	SW40 + PZ/45	SW40 + PW/40	SW60	SW60 + PZ/68	SW60 + PW/60
SKO-P/165	-	1600	1190	1510	1130	1020
SKO-P/180	-	2460	1810	1900	2120	1600
SKO-P/205	-	2500	2500	2500	2500	2500

Maksymalna wysokość rolety wraz ze skrzynką (mm)						
	SW40	SW40 + PZ/45	SW40 + PW/40	SW60	SW60 + PZ/68	SW60 + PW/60
SKT/230/170	-	1460	-	1290	1250	-
SKT/230/210	-	2300	-	2040	1870	-
SKT/255/240	-	2500	-	2500	2500	-

Maksymalna wysokość rolety wraz ze skrzynką (mm)						
	SW40	SW40 + PZ/45	SW40 + PW/40	SW60	SW60 + PZ/68	SW60 + PW/60
SKT NOVA/230/170	-	1290	770	1070	900	560
SKT NOVA/230/210	-	2430	1910	2210	2000	1310
SKT NOVA/255/240	-	2600	2600	2600	2600	2600

Profil PA52

Maksymalna wysokość rolety wraz ze skrzynką (mm)			
	SW60	SW60 + PZ/68	SW60 + PW/60
SK/SKP/SP-E/137	900	580	-
SK/SKP/SP-E/165	1590	1380	1410
SK/SKP/SP-E/180	2060	1800	1480
SK/SKP/SP-E/205	2700	2330	2440

Maksymalna wysokość rolety wraz ze skrzynką (mm)			
	SW60	SW60 + PZ/68	SW60 + PW/60
SKO-P/137	850	640	-
SKO-P/165	1640	1380	1410
SKO-P/180	2060	1860	1900
SKO-P/205	2700	2390	2440

Maksymalna wysokość rolety wraz ze skrzynką (mm)			
	SW60	SW60 + PZ/68	SW60 + PW/60
SKT/230/170	1170	910	950
SKT/230/210	2280	2020	1970
SKT/255/240	3230	2870	2940

Profil PA52 + MKT

Maksymalna wysokość rolety wraz ze skrzynką (mm)			
	SW60	SW60 + PZ/68	SW60 + PW/60
SKT/230/170	910	700	-
SKT/230/210	1450	1450	-
SKT/255/240	2450	2400	-

Maksymalna wysokość rolety wraz ze skrzynką (mm)						
	SW40	SW40 + PZ/45	SW40 + PW/40	SW60	SW60 + PZ/68	SW60 + PW/60
SKT NOVA/230/170	-	-	-	550	550	550
SKT NOVA/230/210	-	-	-	1610	1300	1350
SKT NOVA/255/240	-	-	-	2600	2600	2360

Profil PA55

Maksymalna wysokość rolety wraz ze skrzynką (mm)			
	SW60	SW60 + PZ/68	SW60 + PW/60
SK/SKP/SP-E/137	-	-	-
SK/SKP/SP-E/165	960	1070	-
SK/SKP/SP-E/180	1400	1510	1170
SK/SKP/SP-E/205	1970	2020	1850

Maksymalna wysokość rolety wraz ze skrzynką (mm)			
	SW60	SW60 + PZ/68	SW60 + PW/60
SKO-P/137	-	-	-
SKO-P/165	1010	1070	-
SKO-P/180	1400	1510	1170
SKO-P/205	1910	2020	1910

Maksymalna wysokość rolety wraz ze skrzynką (mm)			
	SW60	SW60 + PZ/68	SW60 + PW/60
SKT/230/170	790	630	-
SKT/230/210	1580	1580	1420
SKT/255/240	2260	2370	2270

Zestawy solarne zawierają baterię, która może zostać zamontowana wewnątrz skrzynki lub poza nią, w miejscu osłoniętym od bezpośredniego działania warunków atmosferycznych. W przypadku montażu baterii wewnątrz skrzynki zmianie ulega nawojowość systemu rolet zewnętrznych i jest ona zbliżona do wartości deklarowanych dla rolety ze zintegrowaną moskitierą rolowaną. Prosimy o weryfikację wielkości skrzynki podczas konfiguracji produktu lub jej zwiększenie o jeden rozmiar w przypadku montażu baterii wewnątrz skrzynki rolety.

Nawojowość profili ekstrudowanych

Profil PE41

Maksymalna wysokość rolety wraz ze skrzynką (mm)						
	SW40	SW40 + PZ/45	SW40 + PW/40	SW60	SW60 + PZ/68	SW60 + PW/60
SK/SKP/SP-E/137	-	1100	-	1060	1020	-
SK/SKP/SP-E/165	-	1750	1650	1690	1400	1230
SK/SKP/SP-E/180	-	2000	1900	2190	1850	1480
SK/SKP/SP-E/205	-	2880	2420	3180	2640	2700

Maksymalna wysokość rolety wraz ze skrzynką (mm)						
	SW40	SW40 + PZ/45	SW40 + PW/40	SW60	SW60 + PZ/68	SW60 + PW/60
SKO-P/137	-	1100	-	960	650	-
SKO-P/165	-	1610	1400	1530	1410	1150
SKO-P/180	-	2030	1780	2150	1860	1570
SKO-P/205	-	3070	2790	2700	2450	2500

Profil PE55

Maksymalna wysokość rolety wraz ze skrzynką (mm)						
	SW60	SW60 + PZ/68	SW60 + PW/60	SW70	SW70 + PZ/78	SW70 + PW/70 + PZ/710
SK/165	1010	850	-	-	-	-
SK/180	1080	1190	1220	-	-	-
SK//205	1800	1750	1800	-	-	-
SK/250	2650	2810	2940	2870	2810	2560
SK/250 + KBS	2650	2760	2780	2590	2650	2500
SK/300	4270	4320	4480	4380	4380	4090
SK/300 + KBS	4930	4430	4640	4540	4540	4480

Nawojowość profili bramowych

Profil PA55

Maksymalna wysokość rolety wraz ze skrzynką (mm)						
	SW60	SW60 + PZ/68	SW60 + PW/60	SW70	SW70 + PZ/78	SW70 + PW/70 + PZ/710
SK/250	3140	3140	3110	3200	3250	2940
SK/250 + KBS	3090	3090	3110	3030	3030	2830
SK/300	4650	5000	4970	4820	5000	4640
SK/300 + KBS	4980	5000	-	5000	5000	5000

Profil PA77

Maksymalna wysokość rolety wraz ze skrzynką (mm)		
	SW70 + PWA70 + WA70	SW70 + PWA70 + WB
SK/250	1610	1790
SK/250 + KBS	1610	1790
SK/300	2460	2760
SK/300 + KBS	3080	3300
SK/350	4920	-