

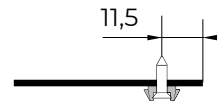

ISTRUZIONI PER L'INSTALLAZIONE - SCHERMO NEL SISTEMA S45/S90

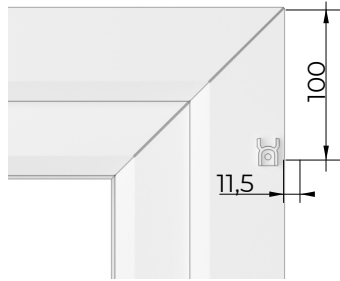

Tutte le dimensioni nel manuale sono in millimetri (mm).

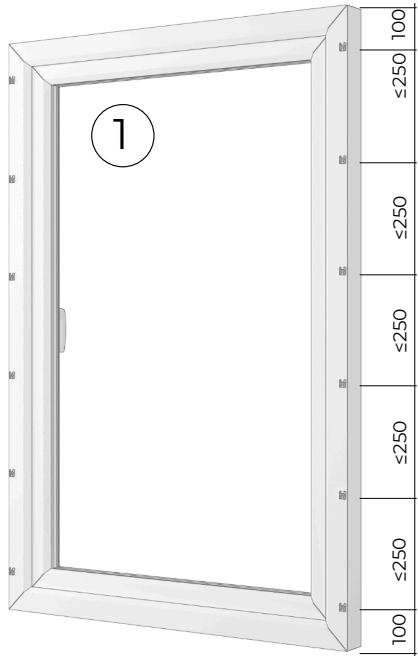
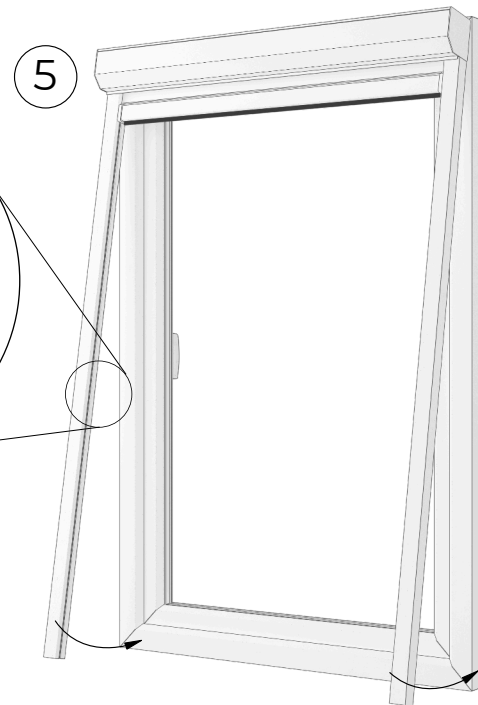
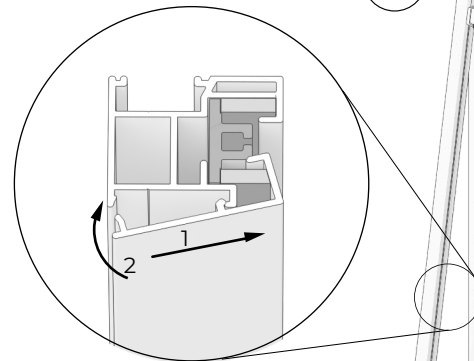
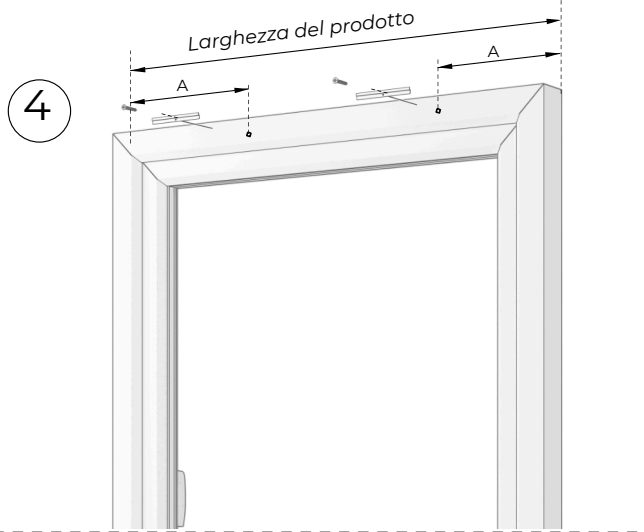
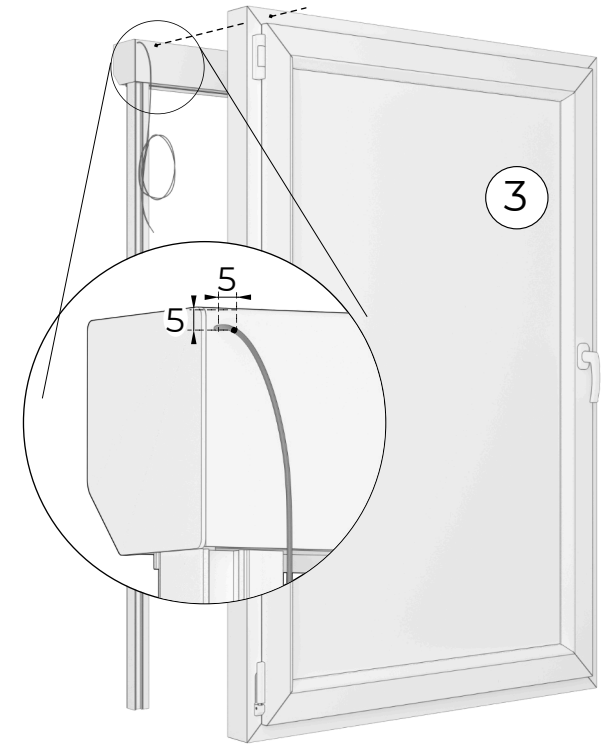
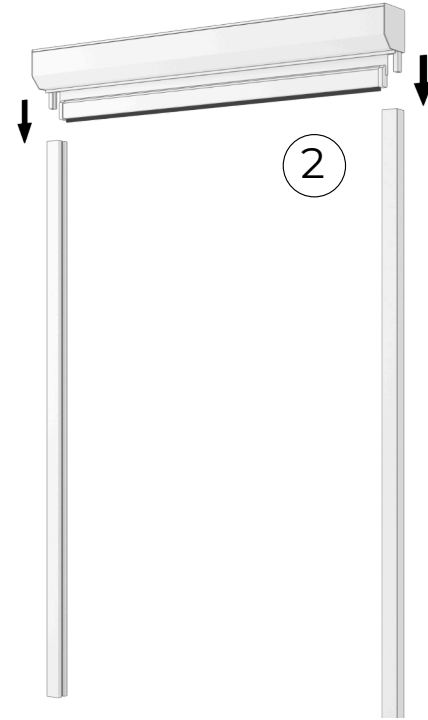

Si applica alle scatole 105 mm e 125 mm

Larghezza del prodotto	Numero di strisce di fissaggio	Massa A
1500-3000	2	250 - 300
3001-5000	2	300 - 800