

2024

ŻALUZJE WEWNĘTRZNE
CENNIK



menu

horizontal aluminum blinds traditional 25 mm, 16 mm	3
horizontal blinds fit line 25 mm	7
horizontal wooden and bamboo blinds 25 mm	10
horizontal wooden and bamboo blinds 50 mm	17
horizontal aluminum blinds 50 mm	23
technical information	28
vertical blinds vertical blinds verticals	30
accessories	39
wooden blinds - quality information	40

HORIZONTAL BLINDS

ALUMINUM TRADITIONAL 25mm, 16mm

- » The louvre is made on a steel gutter with 25 mm and 16 mm wide lamellas,
- » Rolling up and down the blinds with a cord,
- » Adjusting the tilt of the slats (angle of light entering)
By means of a plastic stick,
- » Up to a width of 37 cm the control and the cord are on opposite sides,
above 37 cm are on the same side,
- » It is possible to equip the blinds with vee guides
There is a possibility to equip the blind with veil guides that keep the blind in place when the window is tilted - at an extra charge (please indicate this information on the order).
- » Possibility to choose different colors for the top rail and lamellas,
- » Two variants of lamellas available: 25 mm and 16 mm

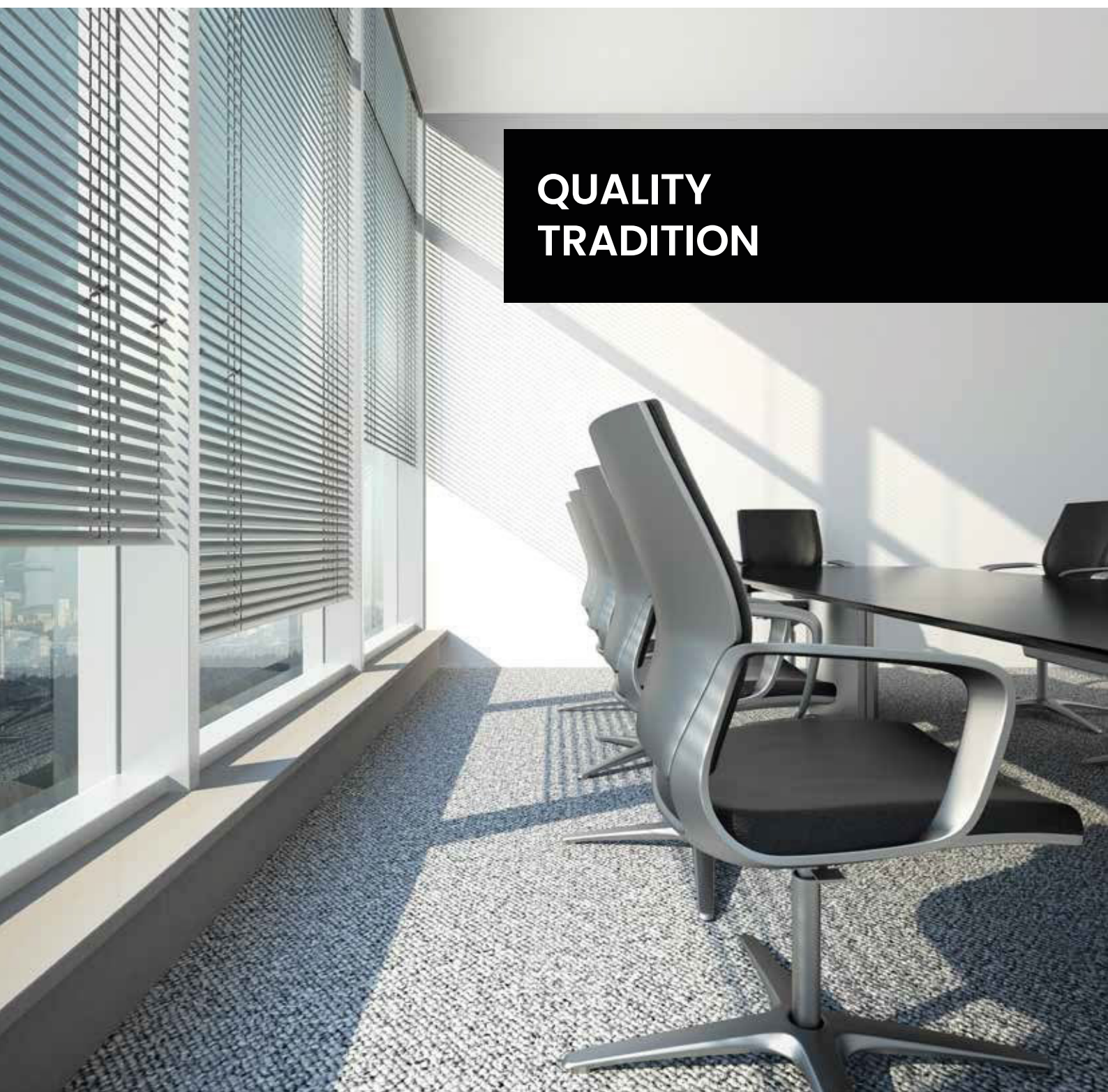

**QUALITY
TRADITION**

MEASUREMENT

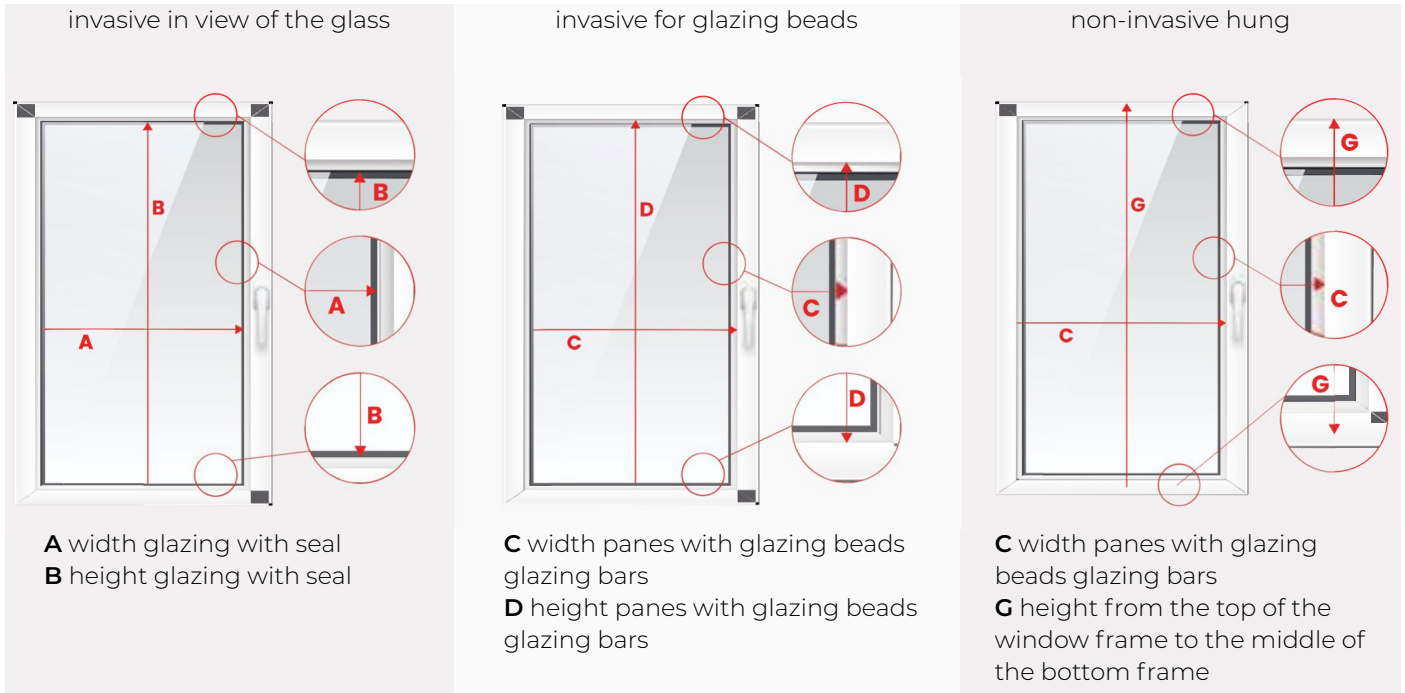

INSTALLATION

invasive ➤ Blind screwed to the glazing bead with installation screws (available in the set)

! In the case of installation up against a wall or niche, the top mount will be used, as in the case of installation for glazing beads.

installation in view of the glass

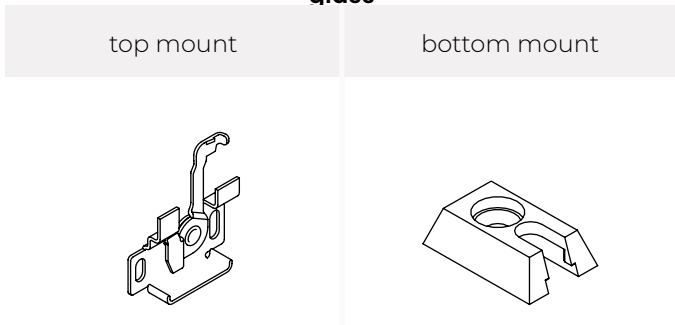

installation for glazing beads

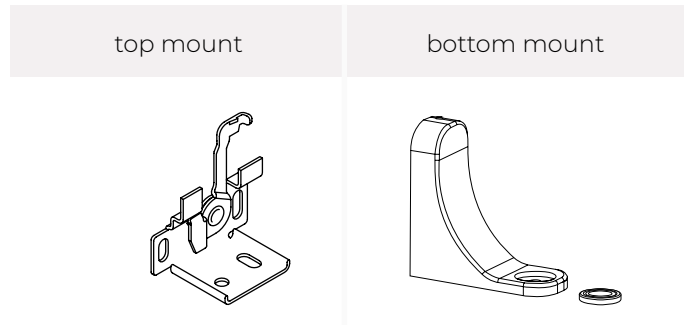

non-invasive ➤ Blind hung on the window sash with non-invasive hangers

installation in view of the glass

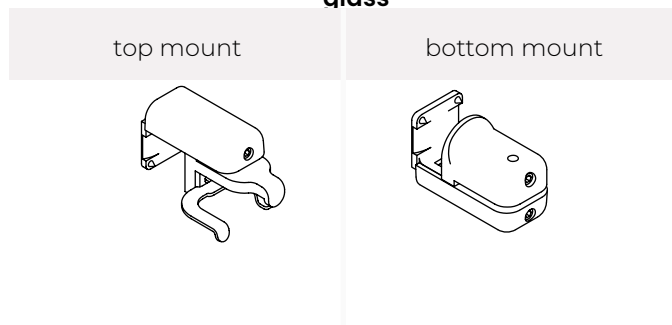

HORIZONTAL BLINDS

ALUMINUM TRADITIONAL 25mm, 16mm

GROUP I 25mm

		width																					
		40	50	60	70	80	90	100	110	120	130	140	150	160	170	180	190	200	210	220	230	240	250
height	40	74	59	65	69	73	78	83	87	91	97	101	105	111	116	121	127	131	135	140	145	149	154
	60	81	66	72	78	85	91	97	103	109	114	121	127	134	141	145	150	158	164	170	175	182	188
	80	89	73	81	88	99	104	113	118	127	135	142	149	158	166	173	179	188	196	204	210	219	226
	100	96	81	89	100	109	117	127	135	144	152	162	171	179	188	196	206	214	224	233	241	250	259
	120	104	89	100	109	122	131	142	150	162	173	183	194	204	213	223	234	246	257	266	275	285	296
	140	112	97	107	118	133	145	157	168	178	190	201	213	224	237	248	259	272	285	298	309	320	331
	160	119	104	117	131	145	158	171	182	196	209	223	237	250	263	275	289	302	316	329	342	355	368
	180	128	113	127	141	157	171	183	201	211	227	243	258	271	285	300	315	330	345	359	373	387	402
	200	135	120	135	150	170	183	201	214	232	248	265	281	297	312	328	344	359	376	392	409	424	439
	220	143	127	145	161	179	198	213	232	250	264	283	302	318	335	353	370	387	405	422	439	456	473
240	150	135	154	173	194	210	231	250	266	285	304	324	342	361	378	396	417	438	456	473	492	509	
250	159	144	162	181	205	224	242	263	285	303	325	345	364	385	404	422	443	466	485	504	525	545	

Shaded area - blind dimension not covered by warranty

GROUP I 16mm

		width																					
		40	50	60	70	80	90	100	110	120	130	140	150	160	170	180	190	200	210	220	230	240	250
height	40	66	52	55	59	65	69	73	79	81	87	91	97	101	105	110	113	118	122	127	132	136	142
	60	73	58	65	69	76	83	89	94	100	106	113	118	125	131	136	142	149	155	161	167	173	178
	80	81	66	73	80	89	97	103	112	118	127	134	142	149	155	163	171	178	185	192	201	208	216
	100	89	75	83	91	102	112	120	129	136	147	156	164	173	181	191	201	210	219	228	238	246	254
	120	97	81	91	102	114	125	134	146	155	164	177	188	197	208	219	229	240	251	262	271	282	292
	140	105	89	101	113	127	139	150	162	175	185	198	212	224	235	248	258	271	284	295	308	319	332
	160	113	98	112	125	139	154	167	178	192	205	220	234	248	262	273	286	301	316	328	341	355	368
	180	120	105	120	134	151	167	180	196	211	224	241	257	271	285	299	315	330	345	361	376	391	405
	200	128	113	130	146	164	180	196	213	229	246	263	280	297	313	328	345	362	379	396	412	428	445
	220	136	121	139	156	177	195	212	229	247	264	283	301	319	338	356	374	392	411	428	446	463	481
240	145	130	150	168	191	209	228	247	266	285	305	327	345	364	384	403	424	445	463	482	501	521	
250	151	136	158	178	201	222	243	263	284	304	327	347	369	391	410	430	452	476	496	517	538	558	

Shaded area - blind dimension not covered by warranty

SURCHARGES

» fixing the blinds (to be added to the price of the blinds depending on the installation method chosen)

Invasive in view of the glass	with monofilament guidance	30,00
	without vein guide	13,00
Invasive for glazing beads	with monofilament guidance	36,00
	without vein guide	13,00
Non-invasive premium (color of fixings: white, bronze or anthracite)	with monofilament guidance	52,00
	without vein guide	19,00

MINIMUM WIDTH OF THE BLINDS

» with monofilament guidance

» without vein guide

Note: In aluminum blinds 16mm and 25mm - width less than 37cm the control is located on separate sides.

The maximum width of the blinds is about 280cm - on individual request in the Sales Department.

LAMELA COLORS

25MM

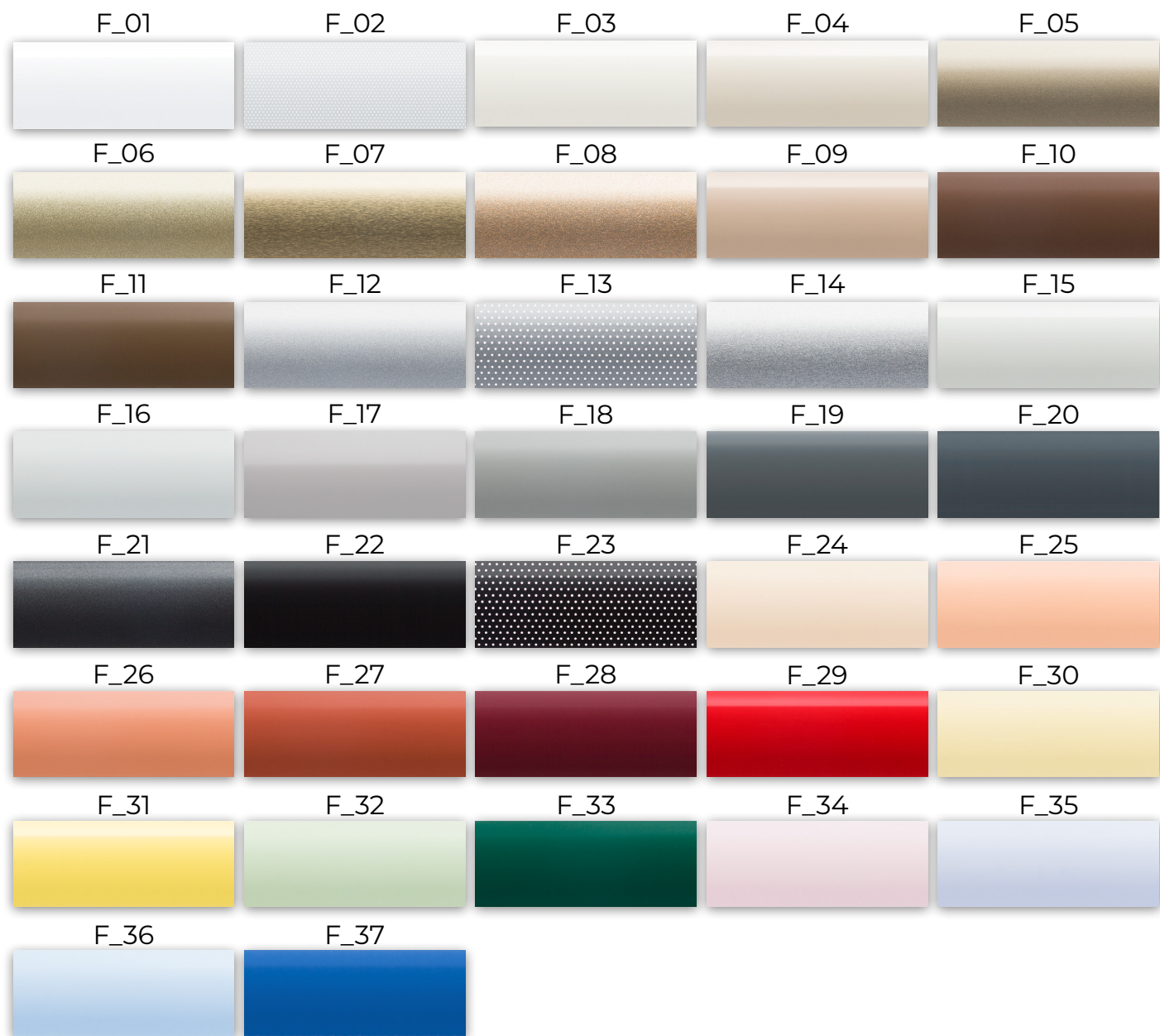

16MM

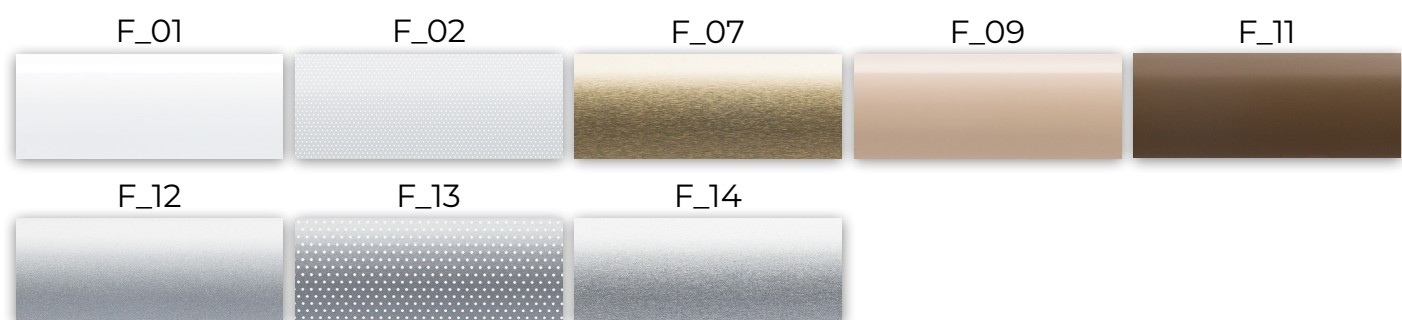

HORIZONTAL BLINDS

ALUMINUM FIT LINE 25mm

- » Blind made of durable aluminum,
- » Mounted invasively to the glazing bead,
- » Standard equipped with a vee guide that keeps the blind in place when the window is tilted
- » Features BLACKOUT - the blind has no holes in the slats so no light passes through,
- » The slats work in view of the glass, thanks to which the blind only slightly protrudes from the window,
- » Adjustment of the angle of the lamellas (the angle of the light coming in), as well as the rolling and unrolling of the blind is carried out by means of a drive chain,
- » The use of spacers allows the installation of blinds in triple-glazed packages



MEASUREMENT

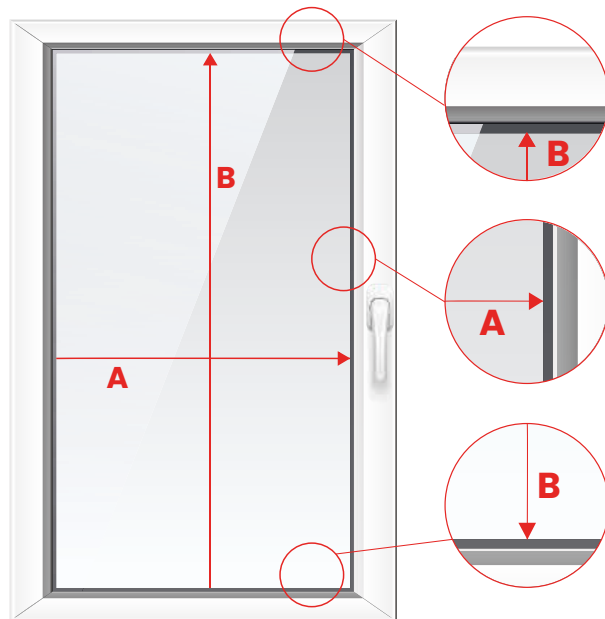

A width glazing (without gaskets)
B height glazing (without gaskets)

The dimensions of the blinds are made according to technical specifications:

- » Width glazing = width lamellas
- » Width glazing + 58mm = width top rail with plugs
- » Height glazing + 20mm = total height louvers (ladder pitch tolerance [+] 20mm)

INSTALLATION

non-invasive

- » Blind screwed to the glazing bead with installation screws (available in the set).

installation

top mount	bottom mount
	standard
	premium

HORIZONTAL BLINDS

ALUMINUM FIT LINE 25mm

height	width																
	40	50	60	70	80	90	100	110	120	130	140	150	160	170	180	190	200
40	76	81	85	89	100	104	109	119	125	129	139	143	147	151	160	164	168
60	83	89	95	100	112	117	124	135	142	147	159	164	170	175	186	191	196
80	93	99	106	113	127	133	141	155	161	168	181	189	195	202	213	220	227
100	99	107	115	124	139	147	155	170	178	187	202	210	218	226	238	247	254
120	109	118	127	136	154	163	173	189	198	207	224	234	243	253	266	275	285
140	115	126	136	147	165	176	187	205	216	237	244	255	266	277	292	302	313
160	125	136	148	160	180	192	205	223	235	247	268	280	292	303	319	331	343
180	131	145	158	171	193	207	220	240	254	267	289	302	316	329	346	360	373
200	141	156	170	185	208	223	237	258	273	288	312	327	341	356	374	389	404
220	147	163	179	194	221	236	252	274	290	307	332	348	364	379	400	416	431
240	157	174	191	208	235	252	269	294	311	328	355	372	389	406	427	445	462
250	178	194	209	224	251	266	281	303	319	334	361	376	391	407	428	445	460

Shaded area - blind dimension not covered by warranty

We recommend making blinds according to the maximum dimensions of the blinds.

Blinds above the maximum area are made at the sole request of the customer - we are not responsible for their functioning.

➤ Minimum width of blinds: 33 cm

➤ Maximum area: 3 m²

➤ Upper and lower gutter colors available: white, bronze, vanilla, gold, gold copper, silver and anthracite)

SURCHARGES

➤ Group Ii (Laths perforowane) 50% to the price of the blinds

➤ spacers 3,00 zł/set

➤ Available colors of spacers: white, bronze, vanilla, gold, gold copper, silver and anthracite)

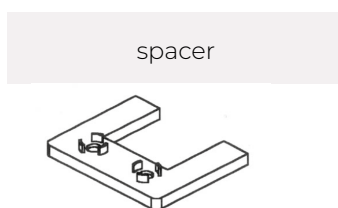

Spacers can be grouped in packages to move the blind cassette away from the window. First of all, spacers are used in windows with triple glazing. We can group the spacers according to the example:

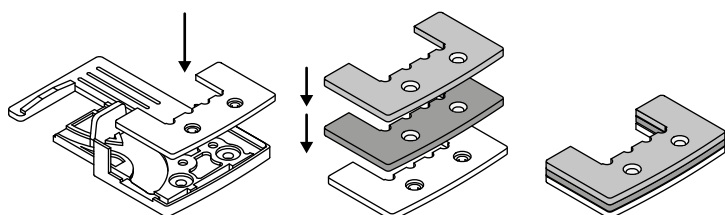

When should a spacer be used?

- Glazing bead depth 79 mm and above-without shim
- Depth of glazing bead 75- 79 mm - one spacer on each side
- Depth of glazing bead 71- 15 mm - two shims on each side

LAMELA COLORS

25MM



HORIZONTAL BLINDS

WOODEN, BAMBOO 25mm

- » The blind is made on a steel gutter with 25 mm wide lamellas,
- » As a standard, the 25 mm blind is made with a top gutter cover and wooden bottom beam in lamellas color,
- » It is possible to use vein guidance,
- » The average weight of 1 m² of bamboo blind is about 7.3 kg,
- » The average weight of 1 m² wooden blinds is about 2.0 kg,
- » Up to the width of 40 cm, the control and the cord are on opposite sides, above 40 cm are on the same side,
- » Colors of cords and ladders are similar to the colors of lamellas,
- » On individual request, it is possible to make a set of blinds - two separate packages mounted in one top rail.



**WOOD
BAMBOO**

HORIZONTAL BLINDS

WOODEN, BAMBOO 25mm

MEASUREMENT

invasive in view of the glass

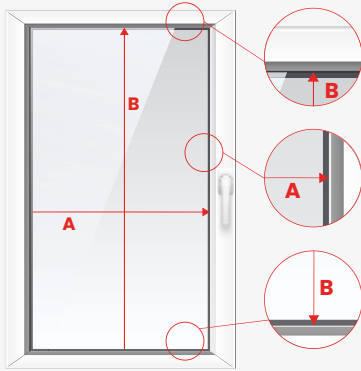

A width glazing with seal
B height glazing with seal

invasive for glazing beads

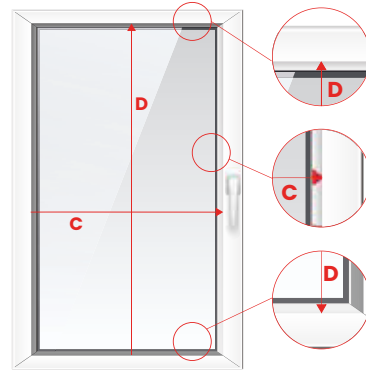

C width panes with glazing beads glazing bars
D height panes with glazing beads glazing bars

non-invasive

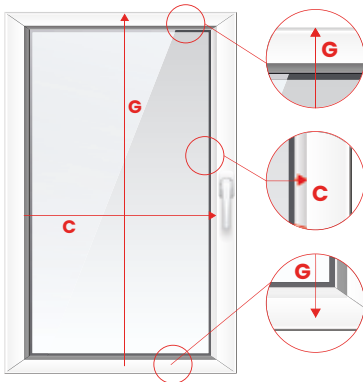

C width panes with glazing beads
glazing bars
G height from the top of the window frame to the middle of the bottom frame

invasive up against a wall or recesses

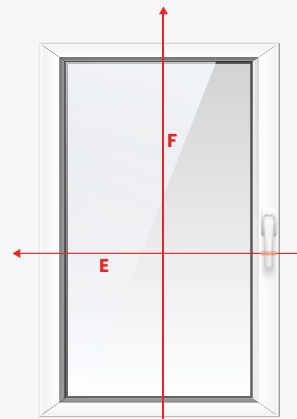

E width total blinds
F height total blinds

HORIZONTAL BLINDS

WOODEN, BAMBOO 25mm

INSTALLATION

invasive ➔ Blind screwed to the glazing bead with installation screws (available in the set)

! In the case of installation up against a wall or niche, the top mount will be used, as in the case of installation for glazing beads.

installation in view of the glass

top mount

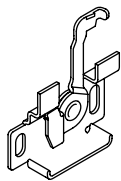

bottom mount

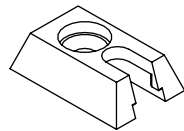

installation for glazing beads

top mount

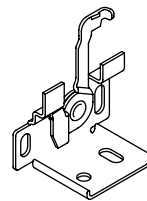

bottom mount

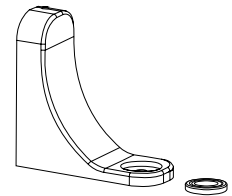

non-invasive ➔ Blind hung on the window sash with non-invasive hangers

installation in view of the glass

top mount

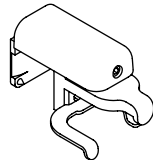

bottom mount

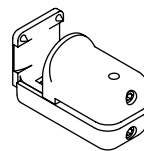

Wooden and bamboo lamellae blinds 25 mm

height we make according to the following technical specifications:

blinds manual control	total height at opening
motorized blinds	total height at closure

HORIZONTAL BLINDS 25mm

BAMBOO

		width															
		40	50	60	70	80	90	100	110	120	130	140	150	160	170	180	
height	40	198	206	219	237	265	279	294	308	321	341	369	386	400	414	432	
	50	209	218	234	254	284	300	318	335	351	372	404	422	438	454	476	
	60	217	227	246	268	299	317	339	357	374	397	431	451	469	487	510	
	70	226	239	261	285	319	341	363	382	404	428	465	487	508	529	555	
	80	237	252	275	303	339	362	387	410	434	461	499	524	547	570	598	
	90	244	262	286	316	355	379	406	432	457	486	527	554	578	603	634	
	100	254	274	301	333	374	401	431	458	485	517	560	590	617	645	677	
	110	268	288	317	353	396	425	457	487	517	552	601	633	662	692	727	
	120	275	298	330	366	411	443	477	508	541	577	628	662	694	725	761	
	130	285	310	345	384	431	466	501	535	569	609	662	698	731	767	806	
	140	296	323	359	401	451	487	526	562	599	640	696	735	771	807	849	
	150	303	332	371	415	466	504	545	584	622	666	723	764	802	840	885	
	160	313	345	386	432	486	527	570	610	652	698	758	801	842	882	928	
	170	323	357	401	449	506	549	594	637	680	729	792	837	880	923	972	
	180	331	368	411	463	522	567	614	659	703	755	819	866	911	956	1007	
	190	359	392	440	494	555	602	652	699	746	800	865	914	961	1010	1062	
	200	369	405	455	511	574	624	676	726	776	832	899	951	1001	1051	1107	
	210	376	415	466	525	590	641	695	747	800	856	926	980	1032	1084	1141	
	220	387	427	481	541	609	664	720	774	829	889	960	1016	1070	1125	1185	
	230	396	439	496	559	629	685	744	801	858	921	995	1052	1109	1167	1229	
240	404	449	508	573	645	703	764	822	881	945	1021	1082	1141	1200	1264		
250	414	462	522	590	664	725	788	849	910	978	1057	1119	1180	1241	1308		
260	432	477	541	609	685	748	814	876	940	1008	1090	1154	1217	1280	1350		
270	441	489	555	626	706	771	838	904	969	1041	1123	1190	1256	1321	1393		
280	451	501	569	644	725	792	862	930	998	1072	1157	1227	1294	1363	1436		
290	458	512	582	657	741	810	882	952	1021	1098	1185	1257	1326	1396	1472		
300	469	524	596	675	760	833	907	978	1050	1129	1219	1293	1365	1438	1516		
310	479	535	610	692	779	854	931	1005	1080	1161	1252	1329	1403	1478	1559		
320	486	545	622	706	796	871	950	1027	1104	1187	1280	1359	1434	1511	1595		
330	497	558	637	723	815	894	974	1053	1133	1218	1314	1396	1474	1553	1639		
340	507	571	652	741	834	916	999	1080	1161	1250	1349	1431	1513	1594	1683		
350	514	580	664	754	850	934	1019	1102	1185	1276	1375	1461	1545	1627	1718		
360	524	592	678	771	870	955	1043	1128	1215	1307	1411	1497	1583	1669	1762		
370	534	605	693	788	890	978	1067	1155	1243	1339	1444	1534	1622	1709	1806		
380	542	615	705	802	906	996	1087	1177	1266	1364	1471	1563	1653	1742	1841		
390	552	628	720	820	925	1017	1112	1204	1296	1397	1505	1600	1692	1784	1885		
400	562	639	735	836	945	1038	1136	1230	1325	1428	1540	1637	1732	1825	1928		
410	570	649	745	850	960	1057	1155	1252	1349	1452	1567	1665	1763	1859	1964		
420	579	662	760	867	980	1079	1180	1279	1378	1485	1601	1702	1801	1900	2007		

Shaded area - blind dimension not covered by warranty

We recommend making blinds according to the maximum dimensions of the blinds.

Blinds above the maximum area are made at the sole request of the customer - we are not responsible for their functioning.

minimum width:

25cm for manual control
58cm for electric control

Maximum area

6 m²



SURCHARGES

» fixing the blinds (to be added to the price of the blinds depending on the installation method chosen)

Invasive in view of the glass	with monofilament guidance	30,00
	without vein guide	13,00
	with steel guide	44,00
Invasive for glazing beads (bottom mount color: white lub bronze)	with monofilament guidance	36,00
	without vein guide	13,00
	with steel guide	50,00
Non-invasive premium (color of fixings: white, bronze or anthracite)	with monofilament guidance	52,00
	without vein guide	19,00
	with steel guide	66,00

ELECTRIC CONTROL

lifting, opening and closing lamellas



Radio drive Somfy Tilt&Lift 25 RTS	692,00 zł /pcs.
Power supply 12 V AC/DC	148,00 zł /pcs.
Remote SITUO I VAR RTS 1-channel (white)	271,00 zł /pcs.
Remote SITUO I VAR RTS 1-channel (silver)	331,00 zł /pcs.
Remote SITUO 5 VAR RTS 5-channel (white)	359,00 zł /pcs.
Remote SITUO 5 VAR RTS 5-channel (silver)	452,00 zł /pcs.

LAMELA COLORS

WOOD 25MM



BAMBOO 25MM

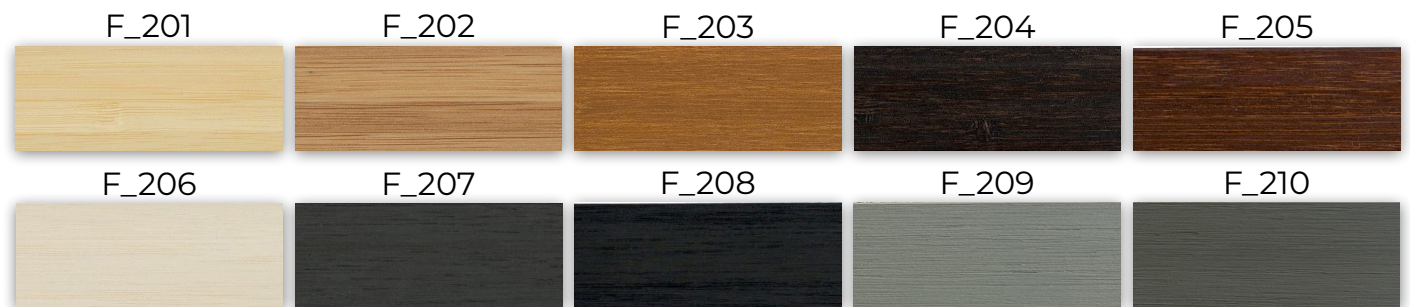

HORIZONTAL BLINDS 50mm

WOODEN, BAMBOO

- » The blind is made on an aluminum gutter with 50 mm wide slats and a tape ladder (it is possible to use a string ladder - without surcharges, such information should be marked on the order).
- » As standard, the blind has a grille with sides and a wooden bottom bar (in color similar to the color of the lamellas).
- » Colors of strings and ladders are similar to lamellas as standard,
- » The louvre does not have vein guidance as standard,
- » The average weight of 1 m² of bamboo blind is about 1.9 kg, the minimum width of the blinds is 30 cm,
- » The average weight of 1 m² of wooden blinds is about 2.3 kg minimum width of the blinds is 30cm,
- » Up to the width of 50cm the control and the cord are on opposite sides above 50cm are on the same side,
- » The maximum recommended dimensions of the blinds are specified in the table,



**WOOD
BAMBOO**



MEASUREMENT

invasive up against a wall lub ceiling

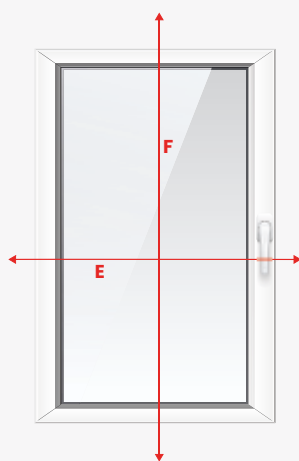

E width total blinds
F height total blinds

INSTALLATION

» **invasive**

**installation up against a wall
lub ceiling**

top mount

bottom mount

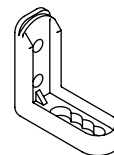
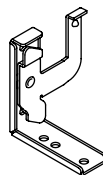

» At installation to the ceiling, the brackets take up 5mm of the height of the louvers (there will be a clearance between the top trough and the ceiling).

Wooden and bamboo lamellae blinds 50 mm

height is made according to the following technical specifications:

blinds manual control

total height at opening

motorized blinds

total height at closure

HORIZONTAL BLINDS 50mm

WOODEN

		width																					
		60	70	80	90	100	110	120	130	140	150	160	170	180	190	200	210	220	230	240	250	260	270
height	40	335	351	370	395	440	458	476	492	509	533	558	585	603	619	642	660	686	726	742	766	783	801
	50	347	366	386	412	461	479	498	517	537	560	589	618	636	655	680	699	727	769	787	812	831	849
	60	364	386	407	438	487	509	531	554	575	602	633	665	687	708	736	756	788	832	854	881	903	924
	70	376	400	423	454	507	531	554	578	601	631	662	697	721	744	772	797	830	875	899	929	952	975
	80	387	412	438	472	526	552	577	602	629	657	693	729	754	781	810	835	871	919	943	974	1000	1026
	90	405	432	461	499	555	583	610	638	667	699	738	775	804	832	865	894	932	982	1011	1044	1072	1100
	100	416	446	476	516	574	603	633	662	692	728	769	808	838	867	904	934	973	1026	1056	1091	1121	1150
	110	433	465	496	539	600	633	664	695	727	763	806	849	882	914	951	982	1024	1076	1107	1145	1167	1207
	120	445	478	510	556	619	652	687	721	753	791	837	882	915	949	988	1021	1066	1120	1152	1190	1225	1259
	130	462	498	534	582	648	684	721	756	791	834	881	930	965	1001	1044	1080	1127	1183	1219	1260	1296	1333
	140	472	510	548	599	667	706	743	781	818	861	912	961	999	1037	1081	1119	1169	1226	1264	1308	1345	1383
	150	485	524	563	617	687	727	766	805	845	889	942	993	1033	1073	1119	1158	1210	1270	1309	1354	1394	1432
	160	497	539	578	634	707	746	788	830	871	917	973	1027	1067	1109	1156	1197	1251	1313	1354	1401	1442	1484
	170	514	558	602	659	733	778	821	865	910	958	1017	1073	1118	1161	1210	1255	1313	1377	1421	1470	1515	1558
	180	525	572	617	677	753	800	845	891	936	988	1047	1106	1151	1197	1248	1294	1354	1420	1465	1517	1563	1609
	190	555	602	650	712	790	837	884	932	980	1032	1095	1156	1202	1250	1303	1351	1413	1482	1530	1583	1631	1678
	200	572	622	672	737	818	868	919	969	1018	1074	1140	1202	1253	1303	1357	1409	1474	1546	1597	1653	1702	1752
	210	584	635	687	755	837	889	941	992	1046	1103	1170	1234	1286	1338	1396	1447	1516	1588	1642	1699	1751	1803
	220	595	649	702	772	856	910	963	1017	1072	1130	1200	1266	1320	1373	1433	1487	1557	1633	1687	1747	1800	1853
	230	607	662	717	790	876	931	987	1043	1098	1159	1231	1298	1354	1410	1471	1525	1599	1676	1732	1793	1848	1904
240	623	681	741	816	904	962	1020	1078	1137	1200	1275	1347	1404	1462	1525	1584	1659	1739	1798	1861	1920	1978	
250	636	696	755	832	923	983	1043	1103	1163	1228	1305	1378	1439	1498	1564	1624	1701	1783	1843	1908	1969	2028	
260	672	733	794	875	970	1032	1093	1156	1217	1283	1364	1435	1497	1559	1626	1688	1767	1846	1907	1975	2037	2098	
270	684	747	810	893	989	1052	1115	1181	1243	1312	1394	1467	1530	1595	1663	1727	1809	1889	1953	2022	2086	2149	
280	701	767	834	919	1017	1083	1150	1216	1281	1353	1439	1516	1581	1647	1718	1785	1870	1953	2019	2091	2158	2223	
290	712	781	848	936	1036	1105	1172	1240	1309	1383	1469	1547	1614	1683	1756	1824	1912	1996	2065	2138	2206	2274	
300	725	793	864	954	1056	1126	1196	1264	1335	1410	1500	1580	1649	1718	1793	1863	1953	2039	2109	2185	2255	2323	
310	742	815	885	978	1084	1156	1229	1301	1373	1451	1543	1626	1698	1771	1848	1921	2013	2103	2177	2254	2326	2398	
320	753	827	901	997	1104	1177	1252	1326	1399	1480	1574	1658	1733	1807	1886	1960	2055	2147	2221	2290	2374	2449	
330	766	840	916	1013	1123	1199	1274	1351	1427	1507	1604	1690	1767	1842	1924	1999	2097	2190	2265	2348	2423	2499	
340	777	855	932	1031	1142	1219	1297	1374	1452	1536	1634	1723	1801	1878	1961	2038	2138	2234	2311	2394	2472	2549	
350	793	875	954	1057	1170	1250	1331	1411	1491	1578	1679	1770	1851	1931	2016	2097	2199	2297	2377	2463	2544	2624	
360	805	888	970	1074	1189	1272	1353	1435	1518	1604	1710	1801	1884	1966	2054	2136	2240	2340	2423	2510	2592	2674	
370	817	900	985	1091	1209	1293	1377	1461	1545	1634	1739	1833	1918	2001	2091	2176	2282	2382	2467	2557	2640	2725	

Shaded area - blind dimension not covered by warranty

Maximum area

6 m²



**control
manual:**

minimum width 30 cm/ maximum height 460 cm

Maximum area

9 m²



**control
electric:**

minimum width 70 cm/ maximum height 460 cm

We recommend making blinds according to the maximum dimensions of the blinds.

Blinds above the maximum area are made at the sole request of the customer - we are not responsible for their functioning.

HORIZONTAL BLINDS 50mm

WOODEN

		width																					
		60	70	80	90	100	110	120	130	140	150	160	170	180	190	200	210	220	230	240	250	260	270
height	40	325	341	356	379	424	439	455	471	486	508	531	557	573	606	638	654	680	718	736	766	783	801
	50	336	354	371	396	442	460	477	494	512	534	560	587	605	641	676	694	722	763	781	812	831	849
	60	353	373	392	421	469	489	509	529	549	574	603	634	653	694	731	753	783	827	848	881	903	924
	70	364	386	407	438	488	509	531	553	574	601	633	664	685	729	769	792	824	871	894	929	952	975
	80	375	399	422	455	507	530	554	576	600	629	662	695	718	764	807	832	866	914	939	974	1000	1026
	90	392	418	443	480	533	559	586	610	637	669	705	741	767	817	863	890	927	978	1006	1044	1072	1100
	100	403	431	457	496	552	579	607	635	663	696	735	772	800	852	900	929	970	1022	1051	1091	1121	1150
	110	420	448	478	518	578	607	637	666	695	731	771	813	843	898	950	980	1022	1074	1104	1145	1167	1207
	120	431	462	493	535	596	629	659	690	722	758	801	844	876	934	987	1019	1064	1118	1150	1190	1225	1259
	130	447	480	514	559	624	657	691	725	759	798	843	890	923	986	1043	1078	1126	1182	1216	1260	1296	1333
	140	457	494	529	577	642	678	713	748	784	824	873	921	955	1021	1080	1118	1168	1225	1262	1308	1345	1383
	150	469	507	544	593	662	698	736	772	809	852	903	951	988	1057	1118	1157	1210	1268	1308	1354	1394	1432
	160	480	519	559	610	680	718	757	797	834	879	931	983	1021	1093	1156	1197	1251	1313	1353	1401	1442	1484
	170	497	539	579	635	707	748	789	831	871	919	974	1028	1069	1145	1212	1255	1313	1377	1420	1470	1515	1558
	180	508	552	594	652	726	769	812	854	897	945	1003	1059	1102	1180	1249	1294	1355	1420	1465	1517	1563	1609
	190	537	583	626	686	761	806	851	895	941	991	1050	1108	1152	1234	1306	1352	1415	1485	1532	1583	1631	1678
	200	554	601	648	711	788	836	883	930	978	1031	1093	1153	1200	1286	1362	1411	1476	1550	1598	1653	1702	1752
	210	564	615	663	727	807	856	905	955	1003	1058	1122	1184	1233	1322	1399	1450	1518	1593	1644	1699	1751	1803
	220	576	628	678	745	825	876	927	978	1029	1085	1152	1215	1266	1356	1438	1490	1559	1637	1690	1747	1800	1853
	230	587	640	693	761	844	897	950	1001	1053	1112	1181	1246	1298	1391	1475	1530	1601	1680	1735	1793	1848	1904
240	604	660	714	786	871	927	982	1036	1091	1152	1225	1291	1347	1444	1531	1587	1663	1745	1801	1861	1920	1978	
250	615	671	729	803	890	946	1003	1061	1118	1179	1252	1322	1379	1480	1569	1628	1705	1787	1847	1908	1969	2028	
260	652	710	769	845	936	995	1052	1111	1169	1234	1310	1378	1436	1541	1632	1693	1773	1853	1914	1975	2037	2098	
270	663	723	783	862	955	1015	1076	1136	1196	1261	1339	1410	1470	1577	1671	1733	1815	1897	1960	2022	2086	2149	
280	680	742	805	886	983	1045	1108	1170	1233	1301	1383	1455	1518	1629	1726	1792	1876	1960	2026	2091	2158	2223	
290	691	755	820	904	1001	1065	1129	1194	1258	1327	1411	1486	1550	1664	1764	1831	1918	2005	2071	2138	2206	2274	
300	702	769	834	920	1019	1085	1151	1217	1283	1355	1441	1518	1583	1700	1801	1871	1960	2048	2117	2185	2255	2323	
310	718	787	856	945	1047	1114	1183	1252	1321	1396	1484	1563	1631	1752	1857	1929	2022	2113	2183	2254	2326	2398	
320	730	801	871	961	1065	1136	1206	1276	1345	1423	1513	1594	1663	1787	1894	1969	2063	2155	2229	2290	2374	2449	
330	741	814	885	978	1083	1155	1228	1299	1372	1449	1542	1625	1696	1823	1933	2008	2105	2199	2275	2348	2423	2499	
340	753	827	899	996	1103	1175	1249	1323	1397	1476	1572	1656	1730	1858	1970	2048	2147	2243	2320	2394	2472	2549	
350	769	846	922	1020	1129	1206	1281	1358	1434	1517	1615	1701	1778	1910	2026	2106	2209	2307	2388	2463	2544	2624	
360	781	858	936	1037	1148	1226	1304	1382	1460	1543	1644	1732	1810	1946	2065	2146	2251	2350	2433	2510	2592	2674	
370	792	871	951	1053	1167	1246	1326	1406	1485	1570	1673	1763	1843	1982	2102	2185	2292	2394	2478	2557	2640	2725	

Shaded area - blind dimension not covered by warranty

Maximum area

6 m²



**control
manual:**

minimum width 30 cm/ maximum height 460 cm

Maximum area

8 m²



**control
electric:**

minimum width 70 cm/ maximum height 460 cm

We recommend making blinds according to the maximum dimensions of the blinds.

Blinds above the maximum area are made at the sole request of the customer - we are not responsible for their functioning.

SURCHARGES

» Implementation of mixed blinds in max. 2 colors

30% to the price of the blinds

ELECTRIC CONTROL

lifting, opening and closing lamellas



Radio drive SONESSE 40 RTS 9/72 (230 V)	798,00 zł/pcs.
Wired drive SONESSE 40 M 9/72 (230 V)	798,00 zł/pcs.
Accessories for electrical control	60,00 zł/mb
Remote SITUO I VAR RTS 1-channel (white)	271,00 zł /pcs.
Remote SITUO I VAR RTS 1-channel (silver)	331,00 zł /pcs.
Remote SITUO 5 VAR RTS 5-channel (white)	359,00 zł /pcs.
Remote SITUO 5 VAR RTS 5-channel (silver)	452,00 zł /pcs.

» The price of blinds with electric control consists of:
price of blinds, motor, additional components, optional remotea/switcher

» When placing an order, specify the following information:
-construction of the bezel (with or without sides)

LAMELA COLORS

WOOD 50MM

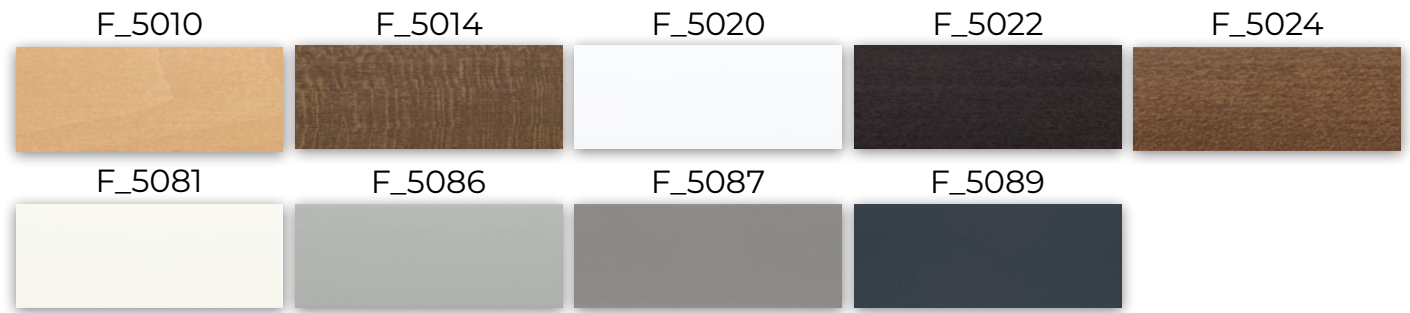

BAMBOO 50MM



HORIZONTAL BLINDS ALUMINUM 50mm

- » The blind is made on a steel gutter with 50mm wide lamellas and string ladders (it is possible to use a 25mm and 38mm tape ladder - at an extra charge),
- » Blind fittings (gutters and strings) are similar to the color of lamellas as standard,
- » There is no possibility to use vee guidance
- » Minimum width of the blinds is 30 cm,
- » With a width of up to 50 cm, the string control are on opposite sides, above 50 cm are on the same side,
- » Slight differences in the shades of the lamellas are allowed,
- » The maximum dimensions are specified in the table,



**ELEGANCJA
W TWOIM
BIURZE I DOMU**

MEASUREMENT

invasive up against a wall lub ceiling

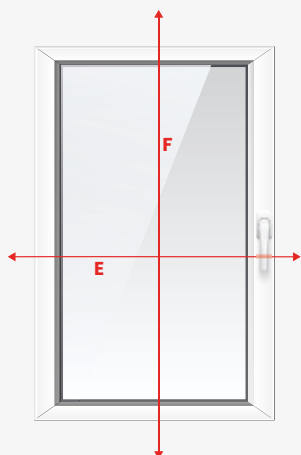

E width total blinds
F height total blinds

price groups for 50 mm aluminum blinds

Group I	Group II
F_5050	F_5050P
F_5051	F_5055P
F_5052	F_5057P
F_5053	
F_5054	
F_5055	
F_5056	
F_5057	

INSTALLATION

» invasive

installation up against a wall
lub ceiling

top mount

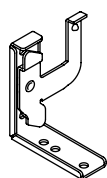

» At installation to the ceiling, the brackets take up 5mm of the height of the louvers (there will be a clearance between the top trough and the ceiling).

Aluminum blinds with slats 50 mm

height is made according to the following technical specifications:

blinds manual control	total height at opening
motorized blinds	total height at closure

GROUP CENOWA NR I LATHS 50mm

		width													
		40	50	60	70	80	90	100	110	120	130	140	150	160	170
height	40	240	250	258	268	277	284	294	308	354	363	372	381	401	408
	50	242	252	261	271	280	289	298	313	359	369	377	387	406	416
	60	244	255	265	275	286	295	305	319	366	376	387	396	418	426
	70	249	258	268	278	289	299	310	326	372	384	393	404	425	435
	80	250	261	271	282	293	302	314	330	377	389	401	410	431	442
	90	253	263	275	287	297	310	320	336	387	396	408	421	442	453
	100	255	267	278	290	301	313	326	341	391	404	415	426	450	461
	110	261	277	289	301	313	326	340	355	405	416	428	441	465	477
	120	263	279	293	304	317	329	341	359	410	423	435	448	471	484
	130	267	282	296	309	321	335	348	366	419	431	445	457	482	495
	140	268	286	298	312	327	339	353	372	424	437	450	464	489	503
	150	270	288	302	316	330	344	357	376	430	443	457	470	497	510
	160	273	290	305	318	333	347	362	381	435	449	464	478	504	518
	170	275	294	309	324	338	353	369	388	442	457	471	486	515	529
	180	278	297	312	327	341	357	372	392	448	464	479	495	522	537
	190	292	311	327	341	357	373	389	409	465	481	497	511	540	556
	200	294	314	331	347	363	378	395	416	472	489	504	522	552	567
	210	297	317	333	350	366	384	401	421	479	495	511	528	559	575
	220	298	319	336	353	371	387	405	426	484	500	518	534	564	583
	230	300	321	339	357	374	391	409	431	489	507	524	542	573	590
	240	304	326	344	362	380	396	416	438	498	515	533	552	584	601
	250	321	344	362	381	400	416	435	460	518	515	555	574	605	623
	260	324	347	365	384	403	421	440	464	524	543	561	579	614	633
	270	326	348	368	387	406	425	445	468	529	548	568	586	620	639
	280	329	351	372	391	410	431	450	476	538	557	576	596	631	651
	290	331	355	375	395	415	435	454	480	543	563	583	603	637	657
	300	332	357	377	397	419	440	461	485	548	568	589	609	646	666
	310	335	362	381	403	424	446	466	492	556	577	599	619	655	677
	320	338	363	386	406	427	449	470	497	561	583	604	626	662	685
	330	340	366	388	409	431	453	476	502	567	589	611	633	670	692
	340	343	369	391	412	435	457	480	507	573	594	617	638	677	699
	350	346	372	394	418	440	464	486	515	580	603	626	649	687	711
	360	347	374	397	421	445	467	489	519	586	609	633	655	695	717
	370	347	374	396	421	446	468	492	521	586	610	633	657	696	721

GROUP CENOWA NR I LATHS 50mm

		width													
		180	190	200	210	220	230	240	250	260	270	280	290	300	310
height	40	418	431	467	486	495	504	514	523	531	544	585	593	603	613
	50	425	440	477	496	504	515	524	533	543	557	598	607	616	624
	60	437	451	489	509	519	529	539	548	559	574	615	624	635	645
	70	446	461	498	519	529	539	548	560	571	585	628	637	648	657
	80	453	469	507	528	539	548	560	572	582	598	638	650	661	671
	90	465	481	519	542	554	563	575	588	599	615	657	668	679	691
	100	472	489	528	552	563	574	586	599	609	626	669	680	692	705
	110	488	506	544	568	580	593	604	617	629	647	689	701	713	726
	120	497	515	554	578	590	603	615	629	639	657	702	713	727	738
	130	508	526	567	591	604	618	631	642	656	675	718	731	745	758
	140	516	534	575	601	614	629	640	654	668	687	731	744	758	771
	150	524	543	584	610	623	637	652	666	679	697	743	756	771	785
	160	533	552	593	619	634	648	662	677	691	710	755	770	784	799
	170	544	563	605	633	648	662	677	692	707	727	772	788	803	818
	180	553	573	615	642	657	672	689	703	718	738	786	801	816	830
	190	572	593	635	664	679	695	711	727	742	762	808	824	840	855
	200	584	604	648	677	693	710	726	742	758	779	827	843	860	875
	210	592	614	656	687	703	721	736	753	770	790	839	855	873	889
	220	599	621	666	696	712	730	746	764	781	803	850	867	884	901
	230	608	630	674	706	723	741	758	775	792	816	863	880	898	915
	240	619	641	687	718	736	755	772	790	808	831	880	899	916	935
	250	642	666	712	744	762	781	800	818	836	860	904	923	941	959
	260	651	675	721	753	772	790	809	829	847	871	916	936	954	973
	270	659	683	729	762	782	801	820	839	859	882	929	949	968	987
	280	670	695	742	775	797	816	835	855	875	899	947	967	986	1006
	290	678	703	751	786	805	825	846	866	885	912	958	978	998	1018
	300	687	712	760	794	816	836	856	878	898	923	971	991	1012	1032
	310	697	724	772	808	830	850	873	894	914	940	988	1010	1031	1052
	320	707	732	781	819	840	861	882	904	925	953	1000	1021	1044	1065
	330	714	742	790	828	849	871	894	915	937	962	1013	1034	1057	1078
	340	722	749	799	837	860	881	904	926	949	975	1026	1047	1069	1091
	350	733	761	810	850	875	896	919	942	965	992	1043	1066	1088	1111
	360	742	770	820	860	883	906	930	954	976	1004	1054	1077	1102	1125
	370	743	771	822	861	884	908	932	956	980	1008	1059	1082	1106	1129

Shaded area - blind dimension not covered by warranty

Maximum area

10 m²

manual control: minimum width to 40cm / maximum width to 310cm / maximum height to 460cm

10 m²

ELECTRIC CONTROL: minimum width to 70cm / maximum width to 310cm / maximum height to 460cm

We recommend making blinds according to the maximum dimensions of the blinds.

Blinds above the maximum area are made at the sole request of the customer - we are not responsible for their functioning.

GROUP CENOWA NR II LATHS 50mm

		width													
		40	50	60	70	80	90	100	110	120	130	140	150	160	170
height	40	249	259	271	282	293	304	315	332	380	391	402	412	434	446
	50	253	265	278	289	301	313	326	343	391	404	416	427	450	462
	60	258	273	287	299	313	327	340	358	409	422	435	449	472	486
	70	263	278	293	308	320	335	349	369	421	435	450	464	488	503
	80	268	282	298	313	329	345	359	380	433	448	464	479	504	519
	90	273	290	308	325	341	357	374	395	450	467	484	500	528	544
	100	278	296	313	331	348	366	385	406	462	480	498	515	544	561
	110	287	309	327	346	364	384	402	425	482	500	519	538	567	585
	120	292	314	333	353	372	391	410	435	495	514	533	553	583	603
	130	297	321	343	363	385	405	425	451	511	532	554	574	607	628
	140	301	327	348	371	392	414	435	463	524	544	567	589	622	642
	150	307	332	355	377	401	423	446	472	534	558	580	603	637	661
	160	310	336	362	385	408	431	454	484	546	571	594	618	653	677
	170	316	345	370	394	421	446	470	500	563	589	615	639	677	702
	180	320	350	376	402	427	453	480	510	576	602	629	654	692	718
	190	336	366	393	421	448	476	501	533	600	628	653	680	721	746
	200	343	374	403	431	460	487	515	548	618	646	674	702	743	771
	210	347	380	409	438	467	496	525	559	630	657	687	716	760	788
	220	351	386	415	446	476	504	535	571	641	671	702	731	775	805
	230	356	390	421	452	483	515	544	580	652	684	715	746	790	822
240	362	397	431	463	495	527	559	598	670	703	736	768	815	846	
250	381	419	451	485	518	553	585	622	697	731	764	799	845	879	
260	386	424	458	492	526	560	594	634	710	744	778	812	861	895	
270	390	428	464	500	534	570	604	646	722	756	791	827	877	913	
280	395	437	472	509	545	583	619	661	740	775	812	849	900	937	
290	401	441	480	516	554	592	629	671	751	788	825	864	916	954	
300	405	447	485	524	562	600	638	681	763	801	840	879	932	971	
310	410	454	495	534	574	614	653	697	781	820	860	899	955	995	
320	415	461	500	541	582	622	662	709	792	834	875	914	971	1012	
330	420	465	507	548	590	632	672	721	805	846	888	929	987	1029	
340	424	470	513	555	599	640	683	730	816	860	901	943	1002	1046	
350	430	478	522	565	609	653	697	746	834	878	922	965	1027	1070	
360	434	483	528	573	618	662	707	756	845	891	936	980	1043	1087	
370	435	485	531	576	622	668	713	764	853	899	943	990	1051	1096	

GROUP CENOWA NR II LATHS 50mm

		width													
		180	190	200	210	220	230	240	250	260	270	280	290	300	310
height	40	456	471	510	531	542	554	563	575	588	603	646	656	667	678
	50	475	489	529	553	563	576	589	600	613	629	672	684	696	708
	60	500	518	559	583	595	609	622	636	649	667	712	726	740	752
	70	517	537	578	603	618	632	647	660	675	694	740	754	768	783
	80	534	555	598	622	638	654	669	685	699	721	766	782	798	812
	90	561	583	628	653	670	687	705	722	737	759	806	823	840	856
	100	578	601	647	675	692	710	727	745	762	786	834	850	868	886
	110	603	629	672	703	722	741	759	777	794	819	868	886	905	924
	120	622	647	693	724	743	762	782	801	820	845	896	915	935	954
	130	648	674	722	754	775	794	817	837	859	884	936	957	977	998
	140	666	692	742	774	797	819	840	862	883	910	962	985	1007	1028
	150	683	711	761	794	818	840	864	885	908	937	990	1013	1035	1058
	160	701	729	781	816	840	863	886	911	934	962	1017	1042	1065	1088
	170	727	756	808	846	871	896	921	947	972	1001	1057	1082	1107	1131
	180	745	775	829	867	894	919	944	971	997	1028	1084	1110	1137	1163
	190	773	805	860	899	926	954	980	1007	1033	1066	1123	1150	1177	1204
	200	801	834	889	930	958	987	1014	1043	1072	1105	1164	1190	1219	1248
	210	818	851	908	951	980	1008	1037	1067	1096	1130	1189	1219	1248	1278
	220	835	869	928	971	1001	1032	1062	1091	1122	1156	1218	1247	1278	1309
	230	853	889	947	992	1021	1053	1085	1115	1146	1183	1244	1276	1307	1338
240	879	916	975	1021	1054	1087	1120	1151	1184	1221	1284	1318	1350	1383	
250	912	951	1011	1058	1091	1125	1158	1191	1225	1263	1323	1357	1390	1424	
260	930	969	1031	1078	1113	1148	1182	1216	1250	1290	1351	1385	1418	1454	
270	949	988	1050	1100	1135	1170	1204	1240	1276	1316	1378	1413	1448	1484	
280	973	1015	1078	1130	1166	1203	1240	1276	1313	1354	1417	1455	1491	1527	
290	991	1033	1098	1151	1188	1225	1263	1301	1338	1380	1445	1482	1521	1557	
300	1008	1052	1118	1171	1210	1248	1288	1325	1364	1408	1472	1510	1549	1587	
310	1034	1080	1146	1202	1242	1281	1321	1360	1401	1446	1511	1553	1593	1632	
320	1052	1098	1166	1222	1263	1303	1344	1386	1427	1471	1540	1580	1620	1661	
330	1070	1115	1185	1243	1284	1327	1368	1410	1451	1498	1566	1609	1650	1692	
340	1088	1135	1204	1264	1307	1349	1391	1433	1477	1524	1595	1637	1678	1722	
350	1113	1163	1234	1294	1338	1383	1427	1470	1515	1563	1634	1678	1723	1766	
360	1130	1181	1253	1314	1359	1404	1449	1495	1540	1588	1661	1706	1751	1796	
370	1143	1195	1266	1328	1372	1418	1465	1510	1556	1607	1679	1726	1771	1817	

Shaded area - blind dimension not covered by warranty

Maximum area

10 m²

manual control: minimum width to 40cm / maximum width to 310cm / maximum height to 460cm

10 m²

ELECTRIC CONTROL: minimum width to 70cm / maximum width to 310cm / maximum height to 460cm

We recommend making blinds according to the maximum dimensions of the blinds.

Blinds above the maximum area are made at the sole request of the customer - we are not responsible for their functioning.

SURCHARGES

» Implementation of mixed blinds in max. 2 colors

30% to the price of the blinds

» Replacing the string ladder with a strap ladder

5% to the price of the blinds

ELECTRIC CONTROL

raising, lowering, opening and closing lamellas



Radio drive SONESSE 40 RTS 9/72 (230 V)	798,00 zł/pcs.
Wired drive SONESSE 40 M 9/72 (230 V)	798,00 zł/pcs.
Accessories for electrical control	60,00 zł/mb
Remote SITUO I VAR RTS 1-channel (white)	271,00 zł /pcs.
Remote SITUO I VAR RTS 1-channel (silver)	331,00 zł /pcs.
Remote SITUO 5 VAR RTS 5-channel (white)	359,00 zł /pcs.
Remote SITUO 5 VAR RTS 5-channel (silver)	452,00 zł /pcs.

» The price of blinds with electric control consists of:
price of blinds, motor, additional components, optional remotea/switcher

LAMELA COLORS

WOOD 50MM

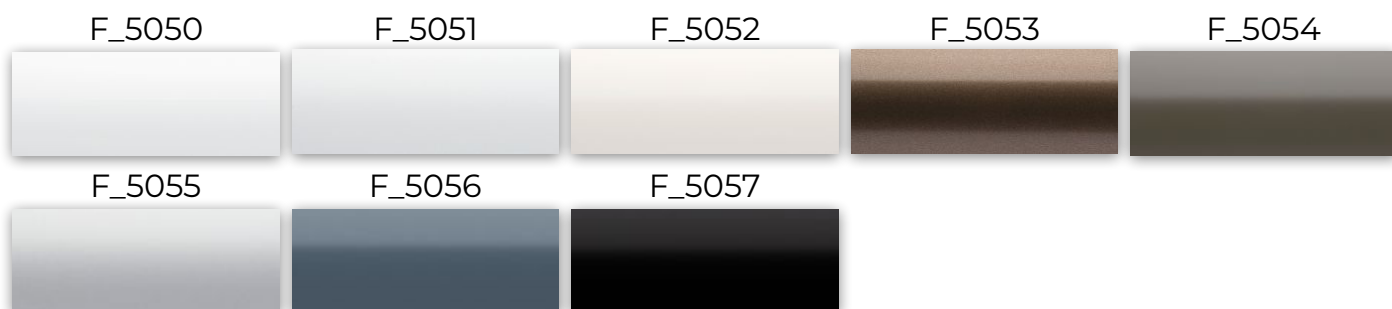

HEIGHTS OF SHUTTER PACKAGES WHEN FOLDED

LATHS 25mm

BLIND WOODEN

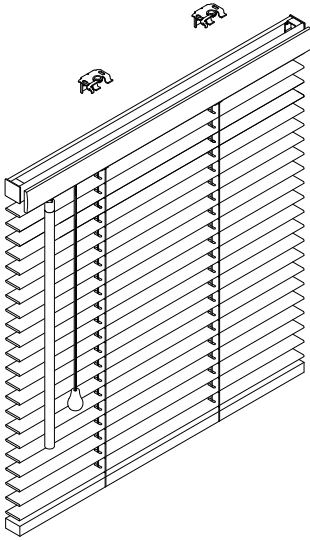

ladder
string
130 mm

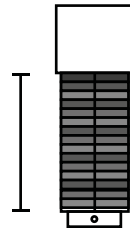

top trough 25 mm
bottom trough 10 mm

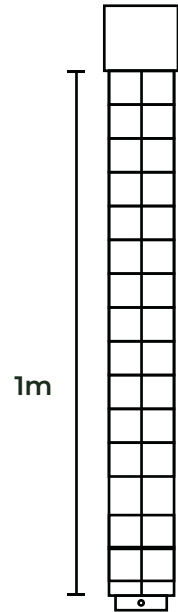

BLIND BAMBOO

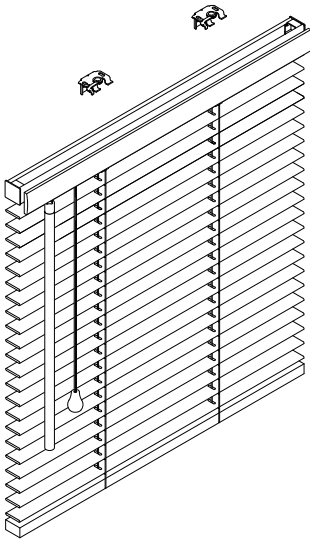

ladder
string
125 mm

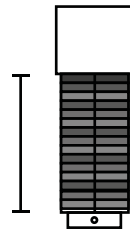

top trough 25 mm
bottom trough 10 mm

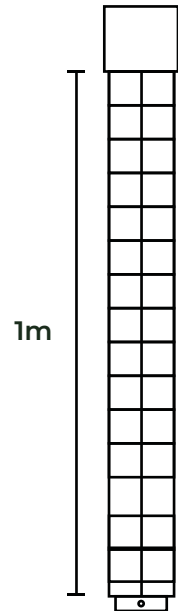

HEIGHTS OF SHUTTER PACKAGES WHEN FOLDED LATHS 50mm

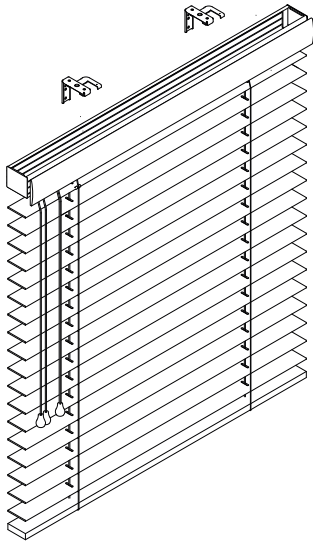

WOODEN

ladder string
75 mm

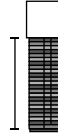

ladder tape
100 mm

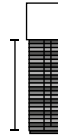

top trough 52 mm
bottom trough 18 mm

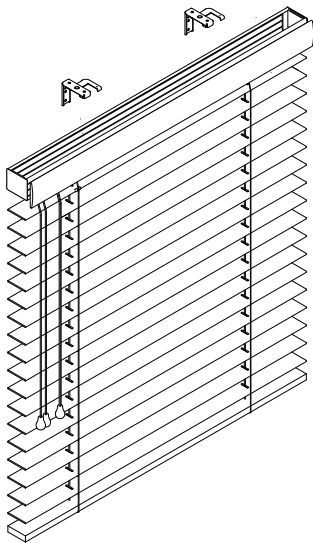
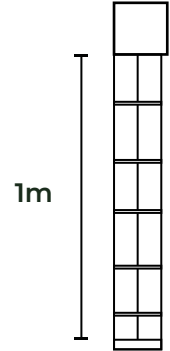

BAMBOO

ladder string
55 mm

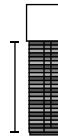

ladder tape
80 mm

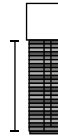

top trough 52 mm
bottom trough 18 mm

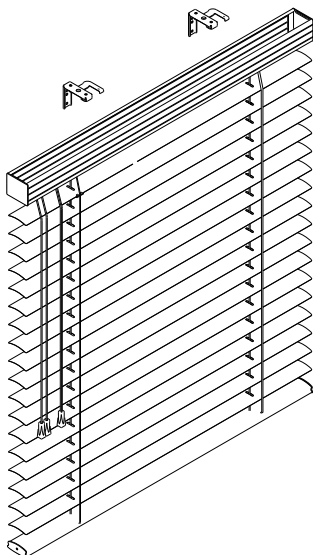
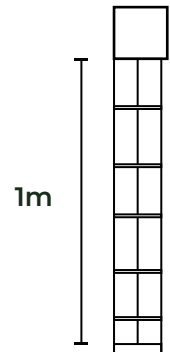

ALUMINUM

ladder string
35 mm

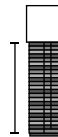

ladder tape
45 mm

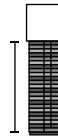

top trough 52 mm
bottom trough 18 mm

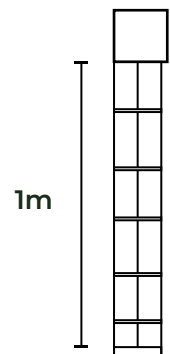

VERTICAL BLINDS VERTICALE 127mm, 89mm

- » Blinds made on aluminum rail with lamellas of 727 mm or 89 mm width,
- » As standard, the blind does not have installation angles,
- » There is a possibility to make oblique blind (maximum angle of inclination 45°)



**IN THE NEW EDITION
EDITION OF**

MEASUREMENT

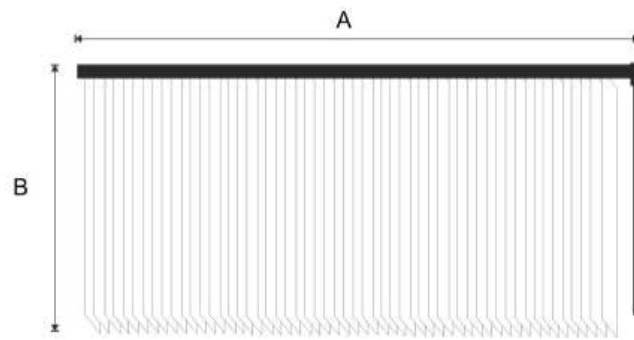

A width total blinds
B height total blinds

The dimension should be reduced so that the blind can move freely.

INSTALLATION

invasive

- » Blind mounted in the niche, outside the niche, to the ceiling and against the wall.

recess, ceiling

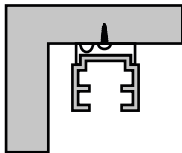

up against a wall, outside the niche
should be marked on the order and add copcs. of angles

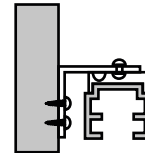

TYPES OF CONTROL

- » TYPE 1 - Covering the lamellas of the blinds is done in the direction of the control mechanism, until full extension is achieved.
- » TYPE 2 - The shutter lamellas are closed from the side of the control mechanism until they are fully extended.
- » TYPE 3 - The shutter lamellas are closed from the outer edges of the rail to the center. This type of installation allows you to use the control mechanism on the right or left side of the blind. There must be an equal number of strips on both sides.
- » TYPE 4 - Covering the louvers' slats is done from the center of the rail to its outer edges. This type of mounting allows you to use the control mechanism on the right or left side of the blind.

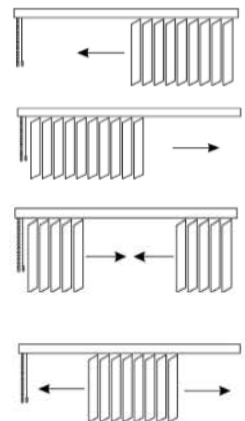

GROUP EDEN 127mm

		width															
		100	120	140	160	180	200	220	240	260	280	300	320	340	360	380	400
height	100	202	227	258	294	312	351	381	418	448	474	504	541	572	618	647	665
	150	222	250	284	326	345	387	420	461	495	523	557	598	632	680	713	734
	170	229	260	294	338	357	401	435	479	514	542	577	620	655	705	742	761
	190	237	269	305	350	370	415	451	496	532	561	598	642	679	731	768	789
	200	241	273	310	355	377	423	459	504	541	572	608	654	690	744	781	803
	210	245	278	317	362	384	430	468	513	551	581	619	665	702	756	794	816
	220	248	283	321	368	390	436	476	522	560	592	629	676	714	769	807	830
	230	252	287	327	374	396	444	482	530	570	600	640	687	726	782	821	844
	240	257	292	332	380	403	451	491	539	580	609	650	699	738	794	834	857
	250	261	297	338	386	410	458	499	548	588	620	661	709	750	807	848	871
	260	264	301	343	392	415	466	507	557	598	629	670	721	762	819	861	885
	270	268	306	347	398	423	472	515	564	607	640	681	732	773	831	874	898
	280	272	310	353	404	428	479	523	574	617	649	691	743	786	844	888	912
	290	276	315	359	410	435	488	530	582	626	658	702	754	797	857	900	927
	300	280	320	364	416	441	494	538	592	635	668	712	766	809	870	915	940
	320	287	329	375	428	455	508	554	607	654	688	733	788	834	895	941	966
	340	296	339	386	441	468	523	571	624	672	707	754	809	857	920	968	994
360	304	347	396	453	480	537	585	642	691	726	774	832	881	945	994	1022	
380	310	356	407	466	493	551	601	659	710	746	796	854	905	971	1021	1049	
400	319	366	418	477	506	565	618	677	728	766	817	876	929	996	1047	1077	

GROUP SAHARA 127mm

		width															
		100	120	140	160	180	200	220	240	260	280	300	320	340	360	380	400
height	100	206	231	263	301	320	359	389	428	459	485	516	555	585	633	663	681
	150	227	258	292	335	355	398	434	477	512	539	575	618	653	703	738	759
	170	237	268	305	349	370	414	451	495	532	561	598	642	679	731	768	789
	190	245	278	317	363	385	431	469	515	553	583	621	667	705	760	797	819
	200	249	283	322	369	391	438	478	524	563	594	633	680	719	773	812	835
	210	252	288	328	376	398	447	486	534	574	605	644	691	732	788	827	850
	220	258	293	333	382	407	455	495	543	584	616	656	704	745	802	842	866
	230	262	299	341	389	413	462	503	553	595	626	667	717	759	815	857	881
	240	266	304	346	396	420	470	513	562	605	638	679	730	771	830	872	896
	250	270	308	352	403	427	478	522	573	616	647	690	743	785	844	887	911
	260	275	314	357	410	434	486	530	582	626	659	703	754	797	858	901	928
	270	280	319	364	416	443	494	539	592	636	669	714	767	812	872	917	942
	280	283	324	369	423	449	502	548	601	646	680	726	780	825	886	932	957
	290	287	329	375	430	456	511	557	611	657	691	738	792	838	900	947	973
	300	292	334	381	436	462	518	565	620	667	702	749	804	851	915	962	989
	320	300	344	393	450	478	535	583	640	688	724	772	829	877	942	991	1019
	340	309	354	405	462	492	550	600	659	709	746	795	854	905	971	1021	1049
360	318	365	416	477	506	565	618	678	730	767	818	878	931	999	1050	1080	
380	327	375	430	491	520	582	636	698	750	789	843	905	957	1026	1081	1111	
400	334	386	441	503	535	598	654	716	771	811	866	929	984	1056	1111	1141	

GROUP KENIA 127mm

		width															
		100	120	140	160	180	200	220	240	260	280	300	320	340	360	380	400
height	100	207	235	266	305	324	364	395	434	466	492	523	562	594	641	672	690
	150	230	262	298	341	362	405	441	483	519	549	584	628	664	714	750	771
	170	240	272	309	355	376	423	459	504	541	572	608	655	691	745	782	804
	190	249	283	322	369	391	438	478	525	563	595	634	680	720	774	814	836
	200	252	288	329	376	399	447	488	535	575	606	645	693	733	790	829	852
	210	258	294	334	384	407	456	496	545	586	618	658	707	748	804	846	869
	220	262	299	341	390	414	465	506	555	597	629	670	721	762	818	860	885
	230	266	305	347	397	423	472	515	565	608	640	682	733	776	834	876	900
	240	271	310	353	405	430	480	524	575	619	651	696	746	790	849	893	917
	250	276	315	361	412	437	490	534	585	630	663	708	760	804	864	908	933
	260	281	321	366	419	445	497	542	596	641	675	720	772	817	878	923	950
	270	285	327	372	426	453	506	552	606	653	686	732	786	831	894	940	965
	280	289	331	378	433	459	515	561	617	663	698	745	800	847	909	955	981
	290	294	338	385	439	468	523	571	626	675	709	756	812	860	923	971	998
	300	299	343	391	448	474	531	580	636	685	721	769	826	874	939	987	1014
	320	307	353	403	461	490	549	598	657	707	744	793	852	901	968	1019	1046
	340	317	364	415	476	504	564	617	677	728	766	817	877	930	998	1049	1079
	360	326	374	428	490	519	582	635	698	750	789	843	905	958	1027	1082	1111
380	334	386	441	504	535	598	654	717	772	812	867	931	986	1058	1113	1144	
400	344	396	454	518	551	616	674	738	795	835	892	957	1014	1088	1144	1176	

GROUP CAPRI 127mm

		width															
		100	120	140	160	180	200	220	240	260	280	300	320	340	360	380	400
height	100	213	240	272	312	331	372	404	445	477	503	536	576	608	656	688	708
	150	238	270	307	352	373	418	455	500	537	566	604	649	686	739	776	797
	170	247	282	321	367	390	436	476	523	562	593	632	678	717	771	811	834
	190	258	293	334	384	407	455	496	545	586	618	658	707	748	805	846	870
	200	262	299	342	391	414	465	507	557	598	630	672	722	763	821	864	887
	210	266	305	347	398	424	474	517	569	611	643	686	737	780	838	881	906
	220	272	310	354	407	432	483	527	578	622	656	700	750	794	854	898	922
	230	277	318	362	414	439	493	537	590	635	668	712	766	811	871	916	941
	240	282	323	368	423	448	502	548	601	646	681	726	781	826	887	933	958
	250	286	329	375	431	456	512	558	612	659	692	740	794	842	905	951	977
	260	292	334	382	437	466	520	569	623	670	705	754	809	857	920	968	996
	270	297	341	389	446	473	530	578	635	684	719	767	824	873	936	985	1013
	280	301	346	396	454	481	539	588	645	696	731	781	838	888	954	1002	1032
	290	307	352	403	461	490	549	599	657	708	744	794	853	903	970	1021	1048
	300	311	357	410	469	497	558	608	668	720	756	808	867	919	986	1038	1067
	320	321	370	424	485	515	576	629	690	745	782	835	896	951	1020	1073	1103
	340	331	382	437	501	531	595	650	713	769	807	863	927	981	1052	1107	1139
	360	342	393	451	516	549	613	670	735	793	832	890	955	1013	1085	1142	1174
380	351	405	466	532	564	632	690	758	817	858	917	984	1043	1118	1178	1210	
400	362	418	479	548	581	650	711	781	842	884	944	1013	1074	1151	1212	1246	

GROUP KAMERUN 127mm

		width															
		100	120	140	160	180	200	220	240	260	280	300	320	340	360	380	400
height	100	219	248	282	323	343	385	419	460	494	522	555	597	630	680	713	734
	150	247	282	321	368	390	437	477	524	563	595	634	680	720	774	814	837
	170	259	296	338	386	410	459	501	550	592	623	665	713	755	813	854	877
	190	270	308	352	404	428	480	524	575	619	653	697	747	791	850	894	919
	200	275	315	361	412	438	491	536	588	633	666	711	765	808	870	915	940
	210	281	322	368	422	448	501	548	601	646	681	726	781	827	888	934	959
	220	286	329	375	431	457	512	559	615	661	696	743	796	844	908	954	980
	230	292	334	384	439	467	523	571	627	675	710	758	814	863	927	975	1001
	240	298	342	391	448	476	534	582	640	689	724	773	830	880	944	994	1022
	250	304	349	399	457	486	543	595	653	703	739	789	848	897	964	1014	1043
	260	308	355	407	467	495	554	606	665	717	753	805	864	916	982	1035	1062
	270	314	363	414	476	504	564	618	678	731	768	819	881	933	1001	1055	1083
	280	320	369	423	483	514	575	629	690	745	782	836	897	952	1021	1074	1104
	290	326	375	431	493	523	586	641	703	759	796	851	915	969	1039	1094	1125
	300	331	382	438	502	534	597	653	716	772	811	867	931	986	1058	1115	1146
	320	343	396	454	519	552	618	676	743	801	839	898	964	1022	1096	1153	1186
	340	353	409	470	538	571	639	700	768	828	870	930	998	1058	1134	1194	1228
360	365	423	485	555	590	661	723	793	855	898	961	1032	1094	1172	1234	1268	
380	376	436	501	574	608	681	746	818	884	928	992	1065	1129	1209	1274	1310	
400	387	449	516	592	628	702	769	844	911	956	1023	1097	1164	1247	1314	1351	

SURCHARGES

» Kamerun FR

Surcharge 10%

GROUP EDEN 89mm

		width															
		100	120	140	160	180	200	220	240	260	280	300	320	340	360	380	400
height	100	247	276	305	352	391	428	468	504	545	593	621	668	698	753	792	821
	150	270	304	335	388	433	472	516	557	600	653	685	737	769	829	873	906
	170	280	315	347	402	449	490	536	576	622	677	710	765	796	859	906	939
	190	288	327	361	416	466	507	555	597	645	701	735	792	826	890	938	973
	200	293	332	367	424	473	516	564	607	657	713	748	805	840	906	954	989
	210	299	338	373	431	481	524	574	618	667	725	761	818	854	920	970	1005
	220	304	343	378	437	490	534	584	628	679	738	773	832	869	935	986	1023
	230	308	349	386	446	497	541	594	639	690	749	786	847	884	951	1002	1039
	240	312	354	391	453	506	551	603	649	701	762	800	860	897	966	1019	1057
	250	318	361	398	459	514	559	613	658	712	774	812	874	912	981	1035	1073
	260	322	366	404	467	522	569	622	668	724	786	825	888	927	997	1050	1090
	270	327	370	410	473	530	576	633	679	735	800	837	900	940	1012	1067	1106
	280	331	376	416	481	538	585	642	689	746	811	851	915	955	1026	1083	1124
	290	335	382	423	489	546	594	651	700	758	824	864	929	969	1043	1100	1140
	300	341	388	430	495	554	603	662	710	769	835	876	942	984	1058	1117	1158
	320	350	399	441	509	571	620	680	731	791	859	901	970	1012	1088	1149	1190
	340	359	410	454	524	586	638	700	751	813	884	928	998	1040	1119	1182	1224
360	368	422	467	538	603	655	720	771	836	908	953	1024	1069	1149	1213	1257	
380	377	433	479	553	619	672	738	792	858	932	978	1052	1098	1181	1246	1292	
400	387	445	491	566	635	689	758	813	881	956	1003	1080	1127	1210	1278	1326	

GROUP SAHARA 89mm

		width															
		100	120	140	160	180	200	220	240	260	280	300	320	340	360	380	400
height	100	250	281	309	357	398	435	476	513	554	603	632	680	709	766	806	835
	150	276	310	343	397	443	482	529	570	615	668	701	754	786	849	894	927
	170	286	322	356	412	459	501	550	592	639	693	728	784	817	881	930	963
	190	296	334	369	427	477	520	571	613	663	721	756	814	849	915	964	1000
	200	301	341	376	435	486	530	581	624	676	734	770	829	865	931	981	1017
	210	306	346	384	444	495	539	592	636	687	747	784	843	880	948	999	1036
	220	310	353	390	450	503	549	601	646	700	760	797	858	896	964	1017	1055
	230	317	359	397	458	513	558	612	658	711	773	812	873	911	980	1035	1073
	240	321	365	404	467	520	569	622	668	724	786	826	888	927	998	1052	1091
	250	326	370	410	474	530	577	633	680	735	801	839	903	942	1014	1069	1108
	260	331	377	416	481	539	586	643	691	748	813	853	918	957	1031	1088	1127
	270	335	384	424	490	548	596	654	702	761	826	867	933	974	1047	1105	1146
	280	342	389	431	497	557	605	664	713	772	839	881	948	989	1063	1123	1164
	290	346	395	437	504	564	616	675	725	785	852	895	962	1004	1080	1140	1183
	300	351	402	444	513	574	624	686	735	796	866	909	977	1020	1097	1158	1200
	320	362	413	457	529	592	643	707	759	821	893	936	1007	1050	1129	1193	1236
	340	372	425	471	543	608	662	727	781	846	918	964	1037	1082	1163	1228	1274
360	381	437	483	559	626	681	748	803	870	944	992	1067	1113	1196	1264	1310	
380	391	449	497	575	644	700	769	825	894	971	1020	1096	1144	1229	1298	1347	
400	402	461	512	590	662	719	790	848	918	998	1047	1126	1175	1263	1334	1383	

GROUP KENIA 89mm

		width															
		100	120	140	160	180	200	220	240	260	280	300	320	340	360	380	400
height	100	257	287	318	367	409	447	489	527	569	618	647	698	727	785	827	857
	150	284	321	354	410	457	499	546	587	636	691	725	781	814	877	924	958
	170	296	333	369	427	477	519	571	613	663	721	756	814	849	915	964	1000
	190	306	347	385	445	496	541	594	638	690	750	786	847	884	952	1003	1040
	200	311	354	391	453	506	552	605	650	703	765	803	864	900	970	1023	1061
	210	318	362	399	461	516	562	617	663	717	780	817	880	918	989	1043	1081
	220	323	367	407	470	525	573	628	676	731	794	834	897	935	1007	1062	1102
	230	329	374	414	479	536	583	640	687	745	808	849	913	953	1025	1082	1123
	240	333	381	422	488	545	594	651	700	758	824	864	930	970	1044	1102	1142
	250	340	388	430	495	555	604	663	712	771	838	880	947	989	1062	1121	1163
	260	345	395	436	504	564	615	675	725	785	853	895	963	1005	1081	1141	1184
	270	351	401	445	513	574	624	687	737	800	867	911	979	1023	1100	1161	1205
	280	356	408	451	522	584	636	699	749	812	882	927	997	1040	1118	1181	1224
	290	362	414	458	530	594	646	710	762	826	897	941	1013	1058	1137	1200	1245
	300	367	422	467	539	604	657	722	774	839	912	957	1031	1075	1154	1220	1266
	320	378	434	481	557	623	678	745	800	866	941	989	1062	1109	1192	1258	1306
	340	390	448	496	574	643	699	768	825	894	971	1019	1096	1144	1230	1299	1347
360	401	461	512	592	662	720	791	849	920	1000	1049	1129	1179	1267	1338	1389	
380	412	474	527	607	681	742	815	874	948	1028	1081	1163	1213	1304	1378	1428	
400	423	489	541	624	701	762	838	898	975	1059	1112	1195	1248	1340	1417	1469	

GROUP CAPRI 89mm

		width															
		100	120	140	160	180	200	220	240	260	280	300	320	340	360	380	400
height	100	260	292	322	373	415	455	497	536	578	629	659	710	742	800	843	873
	150	289	328	363	419	469	512	560	603	651	709	744	801	835	899	948	982
	170	303	343	378	437	490	534	585	629	681	740	777	836	872	940	991	1027
	190	314	356	395	456	511	557	611	656	710	772	809	872	910	979	1034	1071
	200	320	364	403	467	520	569	622	669	725	788	827	889	929	999	1055	1094
	210	326	372	411	476	531	580	635	682	739	804	843	908	947	1020	1077	1116
	220	331	378	419	485	541	590	647	697	754	819	860	924	966	1039	1097	1138
	230	339	386	427	494	553	601	661	710	769	835	876	943	985	1059	1118	1160
	240	344	392	435	503	563	613	674	723	783	851	894	962	1003	1080	1140	1182
	250	350	401	444	513	574	624	686	737	797	867	910	979	1022	1100	1161	1204
	260	355	408	451	522	584	636	699	749	813	884	928	998	1040	1119	1182	1225
	270	362	414	459	531	595	646	711	763	827	898	943	1015	1060	1140	1204	1247
	280	367	422	468	540	605	658	724	777	842	915	959	1034	1079	1160	1224	1269
	290	374	428	476	550	616	669	735	790	857	931	977	1050	1097	1179	1246	1292
	300	380	436	482	559	626	681	748	804	871	947	993	1069	1116	1199	1267	1314
	320	391	450	499	577	646	703	773	830	900	978	1026	1105	1153	1239	1310	1358
	340	403	466	515	596	668	726	800	857	930	1011	1060	1141	1190	1279	1351	1402
360	415	479	531	615	689	749	825	884	958	1042	1094	1176	1229	1319	1394	1446	
380	427	494	548	633	710	771	849	911	989	1073	1127	1212	1266	1359	1437	1489	
400	439	508	563	651	731	794	874	938	1017	1105	1161	1248	1304	1398	1479	1533	

SURCHARGES

- » slanted blind 50% to the price of the blinds
- » mounting bracket (added if mounted to wall) 3,00 zł/pcs.
* the supplied strips require cutting during installation

ADDITIONAL ACCESSORIES

shutter rail	59,00 zł/mb
slanted blind rail	88,00 zł/mb
lamella weight	2,00 zł/pcs.
lamella hanger	1,00 zł/pcs.
chain	3,00 zł/mb
laths alone 89 mm [EDEN, PRAGA]	6,00 zł/mb
laths alone 89 mm [SAHARA, KENIA]	6,00zł/mb
laths alone 89 mm (CAPRI)	7,00 zł/mb
laths alone 127 mm [EDEN]	6,00zł/mb
laths alone 127 mm [PRAGA, SAHARA, KENIA]	7,00 zł/mb
laths alone 127 mm (CAPRI)	7,00 zł/mb
laths alone 127 mm [KAMERUN]	8,00 zł/mb

SERVICES

- lamella shortening 4,00 zł/pcs.

FABRIC COLORS

EDEN I



EDEN II



EDEN II

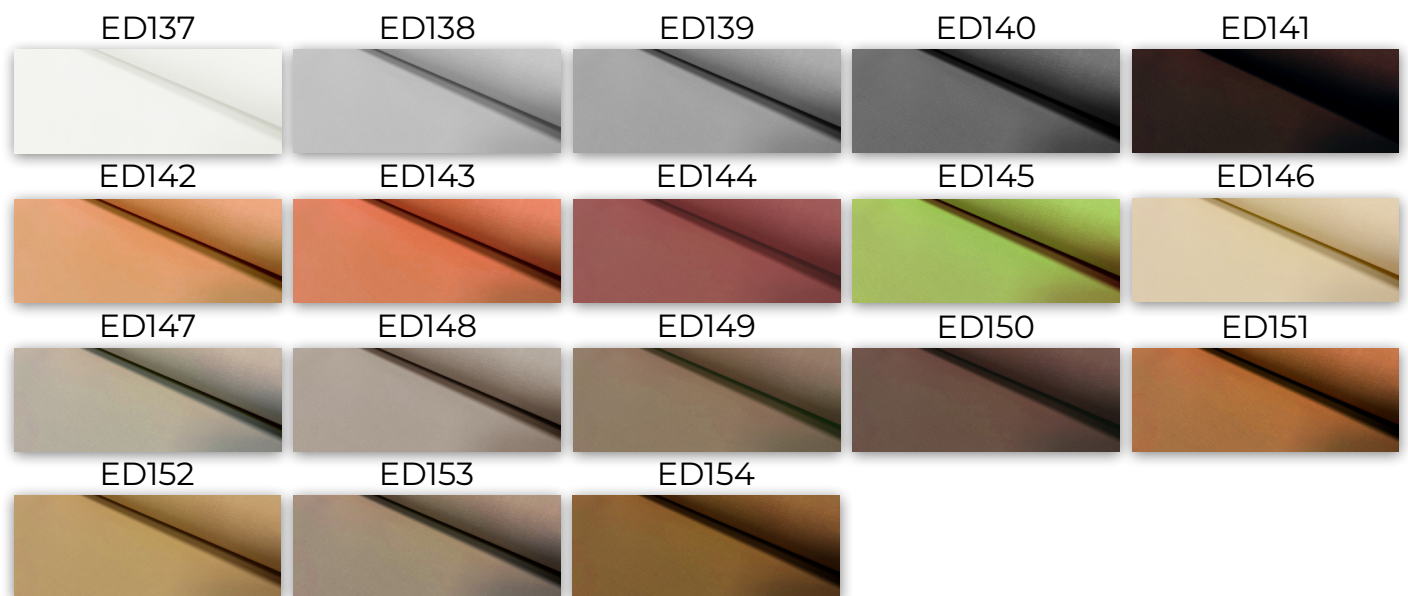

FABRIC COLORS

CAPRI



KENIA



SAHARA

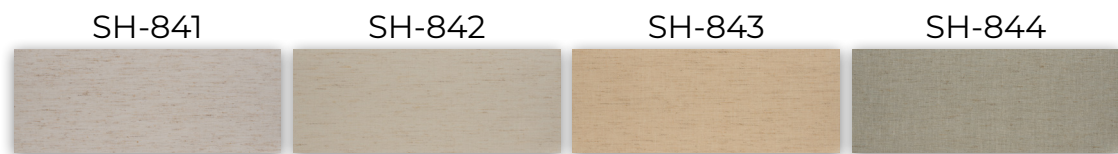

KAMERUN

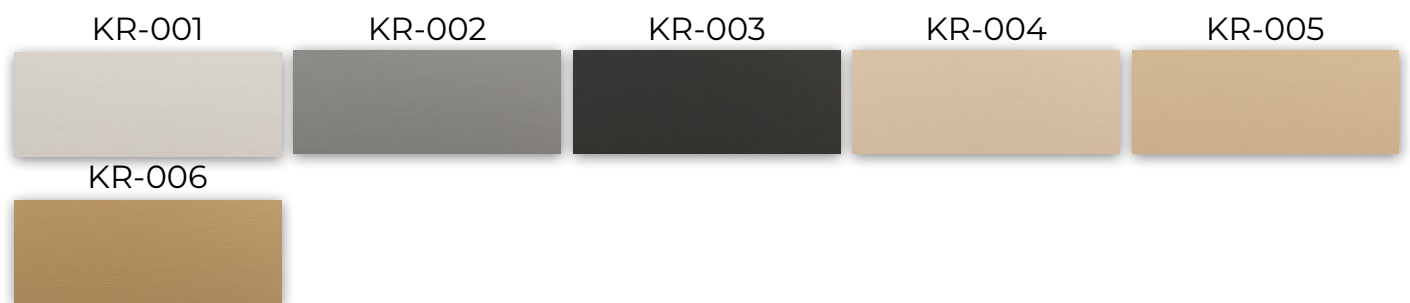

KAMERUN RF



ACCESSORIES

Bracket for installation against a wall	3,00 zł/pcs.
PVC stick for blinds	4,00 zł/mb
Wooden cover, pure, Bamboo - dedicated to 25mm blinds	28,00 zł/mb
Wooden cover, pure, Bamboo - dedicated to 50mm blinds	38,00 zł/mb
Laminated cover - dedicated to 25mm blinds	30,00 zł/mb
Laminated cover - dedicated to 50mm blinds	42,00 zł/mb
Weight bar wooden, Bamboo, laminated - dedicated to 25mm blinds	33,00 zł/mb
Weight bar wooden, Bamboo, laminated - dedicated to 50mm blinds	44,00 zł/mb
Handle 100 cm	29,00 zł/mb
Handle 150 cm	42,00 zł/mb
String (1.4mm) for 25mm blinds	2,00 zł/mb
String (1.7mm) for 50mm blinds	1,00 zł/mb
End cap for handle for aluminum blinds 16mm/25mm	5,00 zł/pcs.
End cap for string for aluminum blinds 16mm/25mm	5,00 zł/pcs.
Wooden end cap for 1.4mm string	6,00 zł/pcs.
Wooden end cap for 1.7mm string	6,00 zł/pcs.
Side guide bracket in view of the glass	2,00 zł/pcs.
Locking sleeve for cord with screw 4mm	4,00 zł/pcs.
Bracket for side guiding (metal)	6,00 zł/pcs.
Bracket for side guiding (transparent)	3,00 zł/pcs.
Locking sleeve for cord with screw 8mm	4,00 zł/pcs.
Upper gutter cover 16mm/25mm	2,00 zł/pcs.
Lower gutter cover 16mm/25mm	2,00 zł/pcs.
Upper gutter cover 50mm	3,00 zł/pcs.
Lower gutter cover 50mm	3,00 zł/pcs.
Double pin string brake	7,00 zł/pcs.
Worm gear 25 x 25 with cardan dedicated to aluminum blinds 16mm/25mm	4,00 zł/pcs.
Metal worm gear dedicated to wooden blinds 25mm	11,00 zł/pcs.
Worm gear 50mm	14,00 zł/pcs.
Metal twist latch 16mm/25mm	6,00 zł/pcs.
Upper gutter mounting in view of the glass (low metal twist)	4,00zł/pcs.
Upper gutter mounting PVC	4,00 zł/pcs.
Mechanism for 50mm blinds (lock mechanism)	15,00 zł/pcs.
Twist latch 50mm	11,00 zł/pcs.

WOODEN BLINDS – QUALITATIVE INFORMATION

- » FILL's wooden blinds are made of natural material. For their production we use three species of wood: Siberian linden, abachii, bamboo.
- » The unquestionable visual qualities of wooden blinds are usually the crowning argument in choosing the covers. However, it is worth mentioning other advantages of the material as well:

INSULATION

- » wood indicates high thermal insulation properties, so closed louvers can keep the heat inside in winter and protect it from overheating in summer.

ECOLOGY

- » wood itself is a renewable resource, which makes this type of covering considered ecological and planet-friendly. When choosing a product made of wood, it is worth knowing its properties. Wood's hygroscopicity, i.e. its reaction to changes in air humidity, is a natural characteristic of this material. Wood can also react to temperature. The characteristics of blinds resulting from the nature of the processes are not subject to complaint.

CONDITIONS OF COMPLAINT ASSESSMENT OF WOODEN BLINDS

- » The laths are evaluated from two viewing angles: 0° and 45°
- » The evaluation of the product is carried out from a distance of 1 meter. Only defects visible from this distance are considered.
- » A blind not included in the dimensional table of the FILL price list is not subject to complaint.
- » The following features are not subject to complaint.

! Features of wooden blinds not subject to complaint

NATURAL PROPERTIES OF WOOD

- » Changes in the dimension and shape of the lamellae

Wood under the influence of high humidity can expand, in turn, when the humidity decreases the lamellas can return to their original shape. Under the influence of these processes, there may be not only a slight change in the dimensions of the lamellas, but also a modification of the shape. This is due to the natural characteristics of wood.

Tolerance for change in lamella dimensions

torsion

up to 2 mm/m

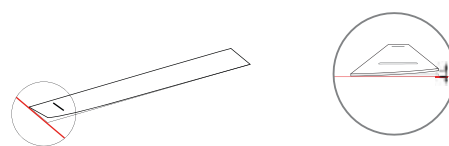

bend

up to 2 mm/m

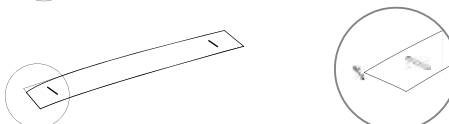

arc

up to 8 mm

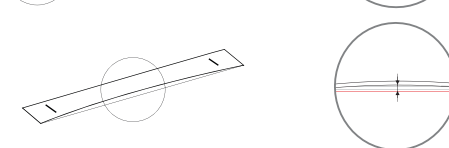

» Differences in the color of the lamellas

Both lamellas in the natural color of wood, as well as painted or stained may slightly differ in shades. The color depends on the base color of the lamellas of the batch. Lamellas within a single cover are not matched for consistency. Due to the differences in shades, it is impossible to match perfectly the same hanging blinds side by side, although we try to make the difference as small as possible.

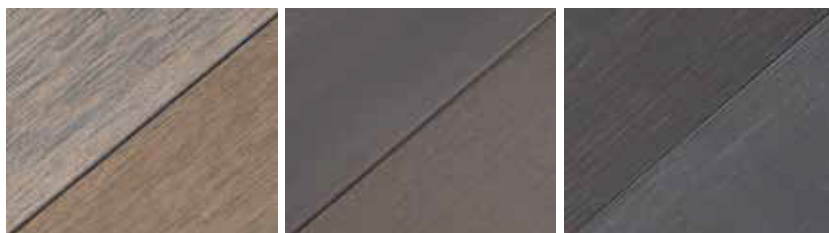

» Occurrence of rings and knots

In the case of wood lamellas, the occurrence and distribution of rings and knots are not subject to complaint. Their occurrence and irregular distribution is due to the natural structure of the wood.

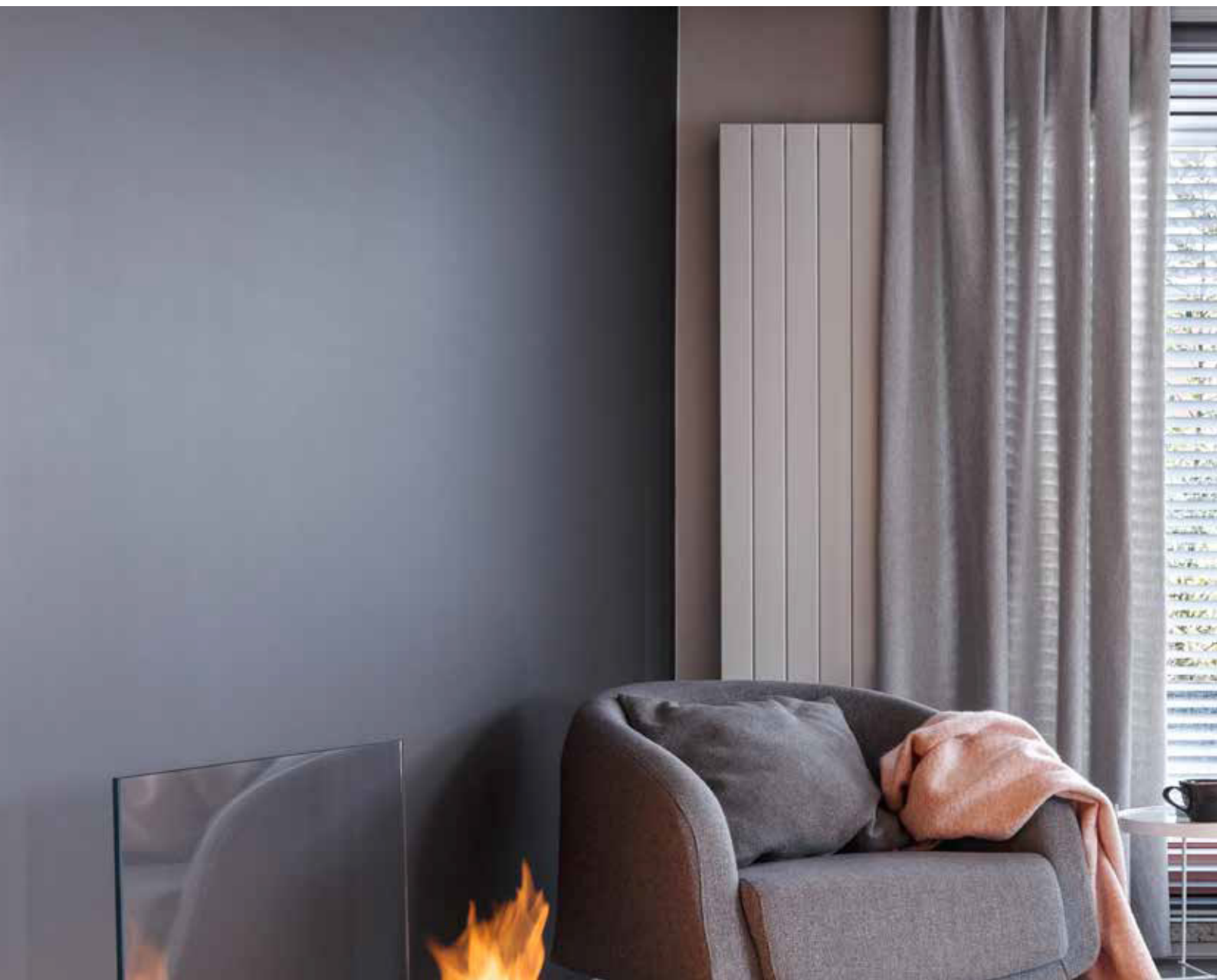
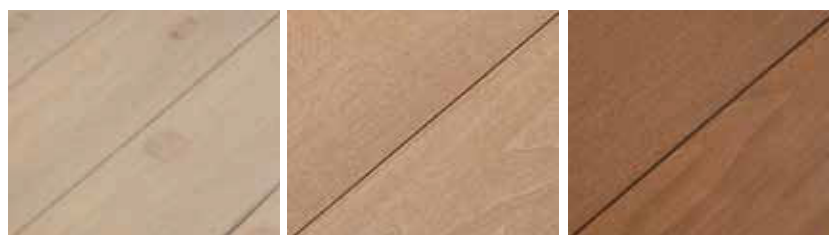

» Lamella surface

Roughness of the edges of the slats, grille and louver weight.

Visible lamella leaf joints, so called. finger joints (micro-bevels).

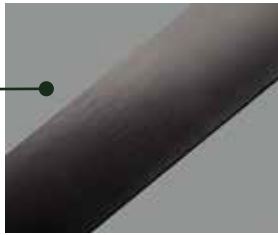

Paint mistakes

Colorful spots



Visible small clearances or micro-cracks
In the lamellas of bamboo blinds.

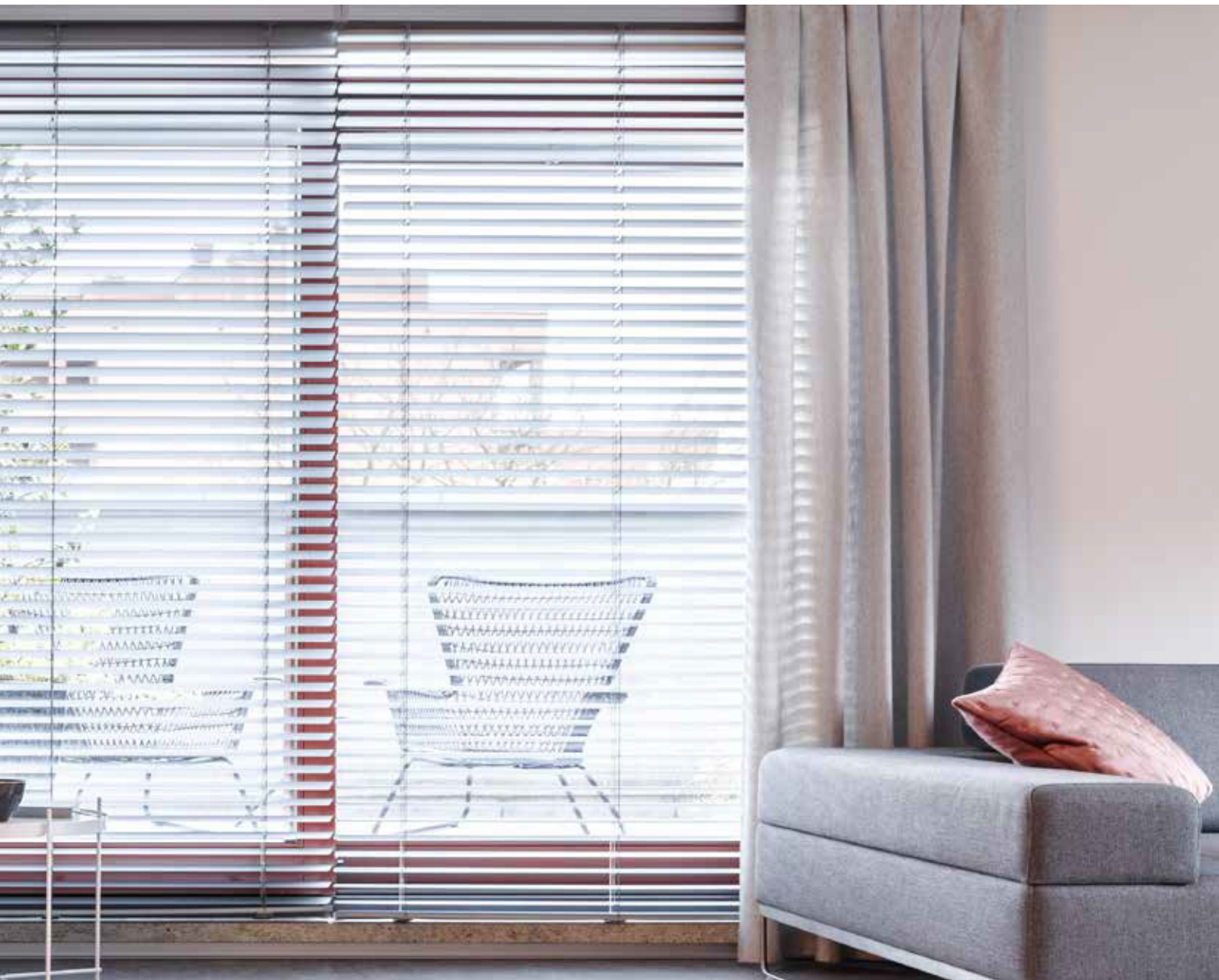

HABERDASHERY

Stretching haberdashery and blind controls.

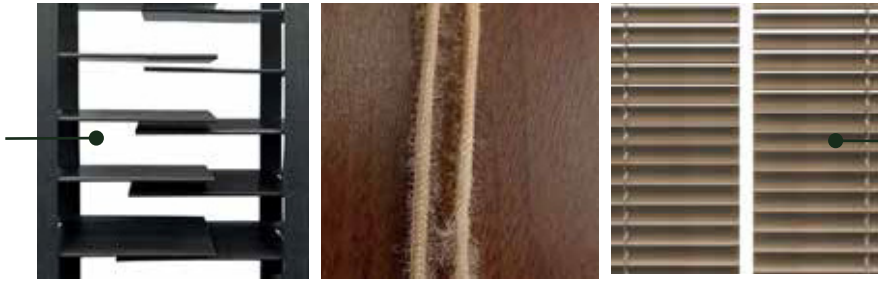

Slight differences in the height of the blinds. Tolerance of differences is -5mm/+35mm

COLORS

» Tinting the lamellas by contrasting ladder. When choosing a dark ladder and a light-colored lamella, there may be a reflection of the tape color on the lamella.

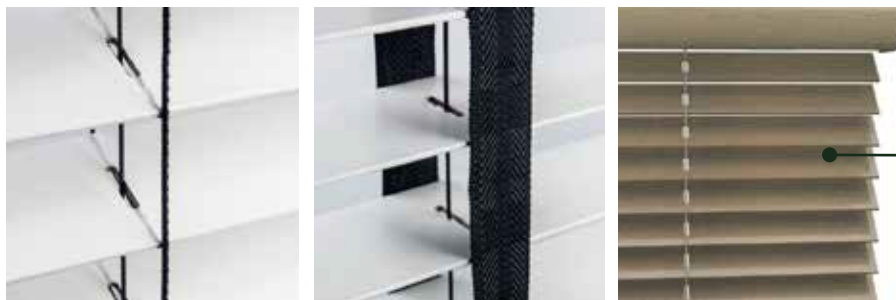

Subtle differences in the colors of gutters and ladders

» The different color of the inside of the holes in dark-colored blinds. When drilling and milling holes for haberdashery in dark-colored wood, it is possible for the natural wood to show through from the inside.

Drilling for string ladder



Milling for the belt ladder.

BENDING PACKAGES FORWARD OR BACKWARD +/- 1CM

» It is also possible to lower the folded blind package on one side opposite the control.

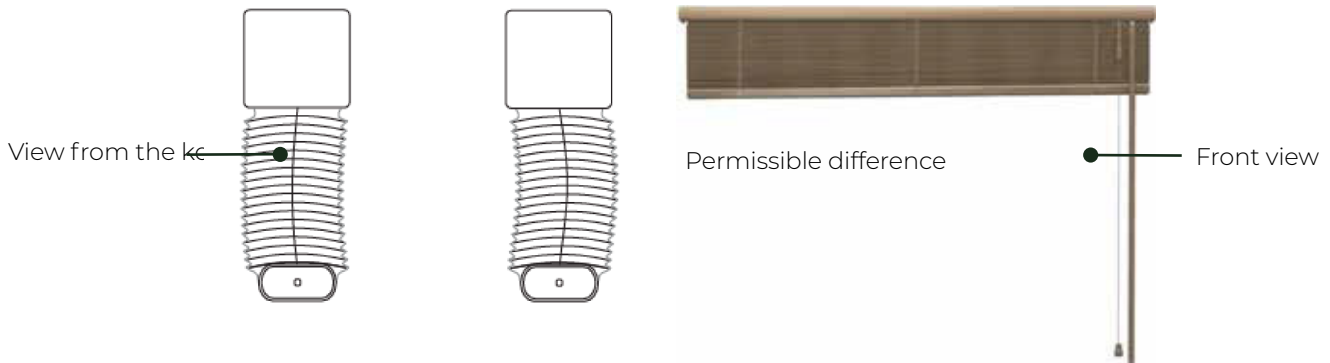

INADEQUATE LENGTH OF CONTROL

» If the customer has not indicated his own control height, the blind is produced according to standard lengths

height of blinds (cm)	control length (cm)
<50	25
50-100	50
100-150	75
150-200	100
200-250	125
>250	150

PROPER CLOSURE OF THE BLINDS

» The correct closure of the blinds, is to direct the lower edge of the slats to the interior of the room.



NOTES



www.fill.com.pl