

TECHNICAL CATALOG

Profile roletowe

KOD	COLOR CODE																																			
	01	02	03	04	05	06	07	08	09	11	12	13	15	16	17	18	19	20	22	23	24	26	28	30	31	33	34	35	36							
PA39	std	std	std	std	std	ldr	ldr	std	std	ex	ex	ex	std	std	ex	ex	ex	ex	std	std	ldr	ldr	ldr	ldr	std	ex	ex	ex	ldr							
PA43	std	std	std	std	std	ldr		std	std				std	std					std	std	ldr	ldr	ldr	ldr	std	ex	ex	ex	ldr							
PA52	std	std	std		std	ldr		std	std			ex	std						std	std			ldr	ldr	std			ex	ldr							
PA55	std	std	std		std	ldr	ldr	std	std				ex	ex	ex	ex			std	std							ex									
PE41		std	std		std			std	std																											
PE55		std	std		std			std	std																											
PA77	std	std	std		std	ldr		std	std										std	std			ldr	ldr												
PER77		std	std		std			std	std																											
LA32																				std																

*std – standard

*ldr – wood-like (lacquer)

*ex – extra

PA39



Profile height 39mm
 Profile thickness 9mm
 Number of strips per 1 m of height 25,6szt.
 Weight 2,8kg
 Maximum area 6m²

PA43

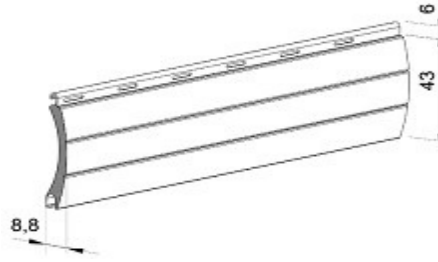

Profile height 43mm
 Profile thickness 8,8mm
 Number of strips per 1 m of height 23,2szt.
 Weight 2,6kg
 Maximum area 9m²

PA52



Profile height 52mm
 Profile thickness 13mm
 Number of strips per 1 m of height 19szt.
 Weight 3,0kg
 Maximum area 8m²

PE41

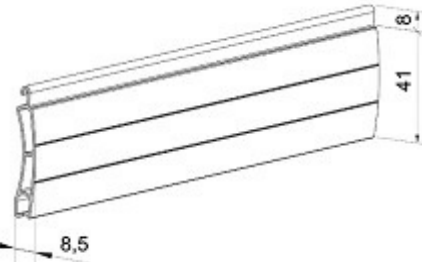

Profile height 41mm
 Profile thickness 8,5mm
 Number of strips per 1 m of height 24szt.
 Weight 7,3kg
 Maximum area 8,5m²

PE55

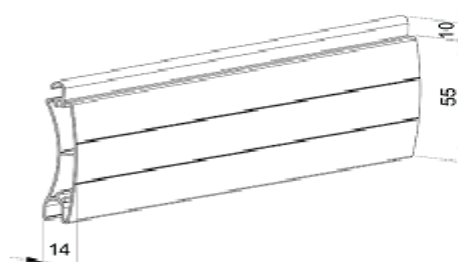

Profile height 55mm
 Profile thickness 14mm
 Number of strips per 1 m of height 18szt.
 Weight 8,7kg
 Maximum area 15m²

PA77

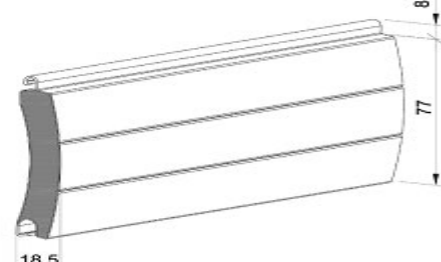

Profile height 77mm
 Profile thickness 18,5mm
 Number of strips per 1 m of height 13szt.
 Weight 4,8kg
 Maximum area 15m²

SK45 roller shutter boxes

CODE	COLOR CODE										
	01	02	03	05	08	09	15	22	23	26	28
SK45/125		std	std		std	std		std	std		
SK45/137	std std	std	std	std	std	std	std	std	std	ldr	ldr
SK45/165	std std	std	std	std	std	std	std	std	std	ldr	ldr
SK45/180	std std	std	std	std	std	std	std	std	std	ldr	ldr
SK45/205	std std	std	std		std	std			std		ldr
SK45/250	std std	std	std	std	std	std	std		std		
SK45/300		std	std		std	std			std		ldr
SK45/350		std	std		std	std			std		
SK45/MKT/165		std	std	std	std	std	std	std	std	ldr	ldr
SK45/MKT/180		std	std	std	std	std	std	std	std	ldr	ldr
SK45/MKT/205		std	std	std	std	std	std		std		ldr

*std – standard

*ldr – wood-like (lacquer)

*odr - wood-like (veneer)

*ex – extra

Box dimensions				
	A (mm)	B (mm)	C (mm)	D (mm)
SK45/125 SK45/137	128 139	125 137	115 127	90 104
SK45/165 SK45/180	167 183	165 180	155 170	130 144
SK45/205 SK45/250	207 255	205 250	195 240	170 208
SK45/300 SK45/350	306 360	300 50	290 350	250 305
SK45/MKT/165	167 183	165 180	155 170	119 133
SK45/MKT/180	207	205	195	158
SK45/MKT/205				

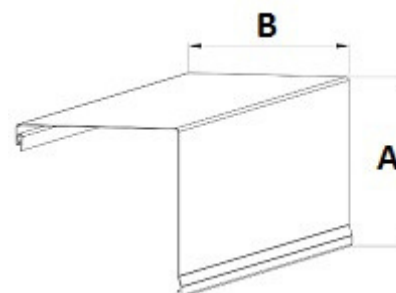

SKP semi-oval roller shutter boxes

CODE	COLOR CODE					
	01	02	03	08	09	23
SKP/137	std	std	std	std	std	std
SKP/165	std	std	std	std	std	std
SKP/180	std	std	std	std	std	std
SKP/205	std	std	std	std	std	std
SKP/MKT/165	std	std	std	std	std	
SKP/MKT/180	std	std	std	std	std	

*std – standard

Box dimensions				
	A (mm)	B (mm)	C (mm)	D (mm)
SKP/137 SKP/165	139	137	129	105
SKP/180 SKP/205	167	165	157	128
SKP/MKT/165	183	180	172	143
SKP/MKT/180	207	205	197	160
	167	165	157	121
	183	180	172	136

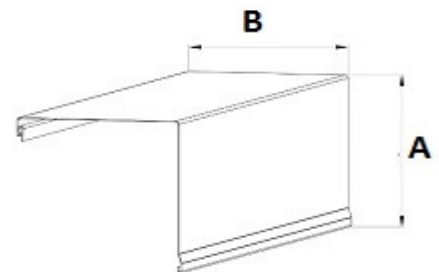

SKO-P Oval roller shutter boxes

CODE	COLOR CODE								
	01	02	03	08	09	15	22	23	34
SHO-P/137 SHO-	std	std	std	std	std	std	std	std	ex
P/165 SHO-	std	std	std	std	std	std	std	std	ex
P/180 SHO-	std	std	std	std	std	std	std	std	ex
P/205 SHO-	std	std	std	std	std	std		std	ex
P/MKT/165 SHO-	std	std	std	std	std				
P/MKT/180	std	std	std	std	std				

*std – standard

*ex – extra

Box dimensions				
	A (mm)	B (mm)	C (mm)	D (mm)
SHO-P/137 SHO-	141	131	113	111
P/165 SHO-P/180	168	157	133	134
SHO-P/205 SHO-	184	171	145	150
P/MKT/165 SHO-	206	195	163	167
P/MKT/180	206	195	145	143

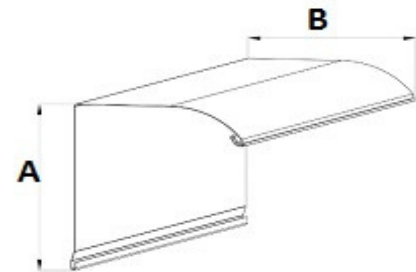

SP-E Integro roller shutter

(inspection cover, bracket)

boxes

COD	COLOR CODE													
	01	02	03	08	09	20	22	23	23R	28R	30R	40S	41S	
SP-E/137 SPE	ex	std	std	std	std	ex	std	std	odr	diff	odr	ex	ex	
E/165 SP-	ex	std	std	std	std	ex	std	std	odr	ere	odr	ex	ex	
E/180 SP-	ex	std	std	std	std	ex	std	std	odr	nt	odr	ex	ex	
E/205 SP-	ex	std	std	std	std	ex	std	std		diff	odr	ex	ex	
E/MKT/205	ex	std	std	std	std		std	std		ere		ex	ex	

*std – standard

*odr – wood-like (veneer)

*ex – extra

nt
diff
ere
nt
diff
ere
nt
diff
ere
nt

Box dimensions				
CODE	A (mm)	B (mm)	C (mm)	D (mm)
SP-E/137 SP-				
E/165 SP-E/180 SP-	137	137	98	111
E/205	165	164	126	139
SP-E/MKT/205	180	180	142	150
	205	205	167	171
	205	205	167	165

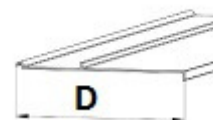
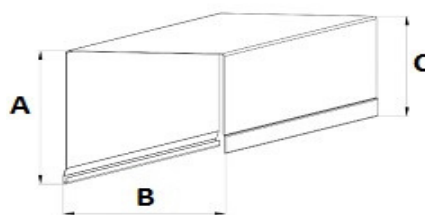

S – special colors on request

SKT Opoterm roller shutter boxes

COD	COLOR	FOIL NAME	FOIL CODE
E	White Brown		
02 08	Anthracite		
23R	Gray	anthracite grey / anthracite	LG KDB74
26R	Mahogany	grey mahogany / mahogany	LG UR602
280R	Walnut Golden	nut / nut golden oak / golden	9.21788007
300R	Winchester	oak winchester / winchester	9.2178001
52R	Winchester	oak winchester / winchester	9.2178001
53R	Oak Dark Oak	dark oak / dark oak	9.0049240
			9.2052089

Box dimensions		
CODE SKT	A (mm)	B (mm)
230/170	230	170
230/210	230	210
255/240	255	240

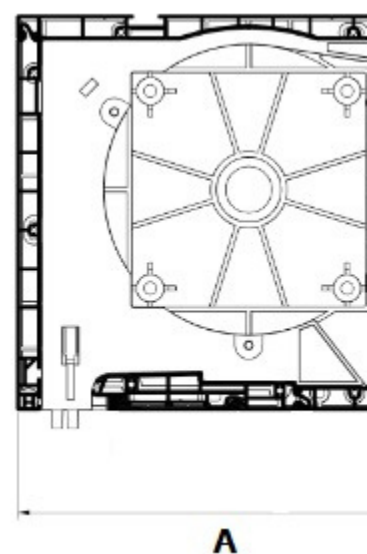

Sides of aluminum boxes

KOD	COLOR CODE															
	01	02	03	05	08	09	15	22	23	26R	28	28R	30	30R	32	34
BS45/125		std	std		std	std		std	std							
BS45/137	ex ex	std	std	std	std	std	std	std	std	odr	ldr	odr	ldr	odr	std	ex
BS45/165	ex ex	std	std		std	std		std	std		ldr	odr	ldr	odr		
BS45/180	ex ex	std	std	std	std	std	std	std	std	odr	ldr	odr	ldr	odr	std	ex
BS45/205	ex ex	std	std		std	std			std	odr	ldr	odr	ldr	odr		
BS45/250	ex ex	std	std	std	std	std	std		std						std	ex
BS45/300	ex ex	std	std		std	std			std		ldr		ldr			
BS45/K/350	ex ex	std	std	std	std	std	std		std						std	ex
BSP/137	ex	std	std		std	std			std							
BSP/165		std	std		std	std			std							
BSP/180		std	std		std	std			std							
BSP/205		std	std		std	std			std							
BSO/137		std	std		std	std			std							
BSO/165		std	std		std	std	std	std	std							ex
BSO/180		std	std		std	std	std	std	std							ex
BSO/205		std	std		std	std	std	std	std							ex
BSO/250		std														
BSO/300		std														

*std – standard

*ldr – wood-like (lacquer)

*odr – wood-like (veneer)

*ex – extra

Cover dimensions	A (mm)
BS45/125	126
BS45/137	140
BS45/165	168
BS45/180	183
BS45/205	208
BS45/250	252
BS45/300	302

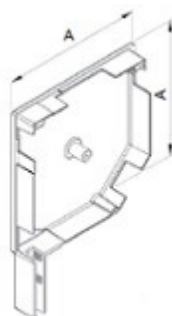

Cover dimensions	A (mm)
BSP/137	137
BSP/165	166
BSP/180	181
BSP/205	206

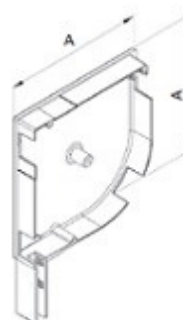

Cover dimensions
BSO/137
BSO/165
BSO/180
BSO/205
BSO/250
BSO/300

S – special color on request. Side colors 28R, 30R, 52R, 53R – subject to individual pricing.

Bottom strips

CODE	COLOR CODE																	
	01	02	03	05	08	09	15	20	22	23	23R	26R	28	28R	30	30R	34	40S
LDG-E	ex	std	std	std	std	std	std	std	std	std	odr	odr	ldr	ord	ldr	odr	ex	ex
LDG52	ex	std	std	std	std	std			std	std					ldr		ex	ex
LDG52/OPT	ex	std	std	std	std	std			std						ldr			ex
LDG/S	ex	std	std	std	std	std			std	std						odr	ex	
LDG/D	ex	std	std	std	std	std			std	std			ldr		ldr			ex
LDG55/W		std	std	std	std	std												ex
LDSM MKT	ex	std	std	std	std	std	std		std	std		odr	ldr	odr	ldr	odr		

CODE	COLOR CODE	
	280R	300R
LDG-E	odr	odr
LDSM MKT	odr	odr

*std – standard

*ldr – wood-like (lacquer)

*odr – wood-like (veneer)

*ex – extra

LDG-E



LDG52

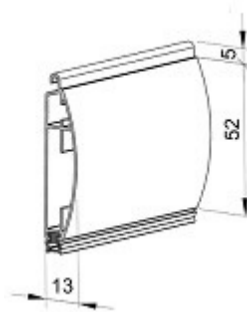

LDG52/OPT



LDG/S



LDG/D



LDSM MKT

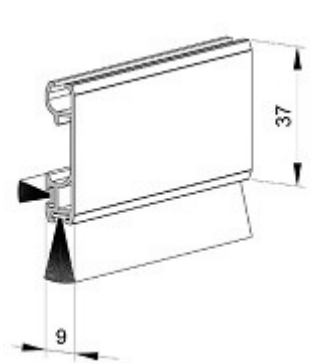

S – special color on request

Aluminum guides

		COLOR CODE																	
CODE		01	02	03	05	08	09	15	20	22	23	23R	26R	28	28R	30	30R	34	
single guides																			
PP45 PU45			std	std		std	std				std								
PP53 PK53			std	std	std	std	std			std	std								
PP53/ODS	ex		std	std	std	std	std	std	std	std	std	odr	odr	ldr	odr	ldr	odr	ex	
PP53/ODS/20	ex		std	std	std	std	std	std		std	std		odr	ldr	odr	ldr	odr		
PPM053	ex		std	std	std	std	std			std	std								
PPD053 PP68	ex		std	std	std	std	std	std		std	std								
PPW66 PP66	ex		std			std	std		std	std				ldr		ldr			
PP75 PP89	ex		std	std	std	std	std	std		std	std	odr	odr	ldr	odr	ldr	odr		
PP110 PPW80	ex		std	std	std	std	std		std	std	std	odr	odr	ldr	odr	ldr	odr		
PPW90			std	std	std	std	std												
	ex		std	std	std	std	std									ldr	odr		
	ex		std	std	std	std	std			std	std							ex	
	ex		std	std	std	std	std			std	std			ldr		ldr			
	ex		std	std	std	std	std			std	std								
			std	std	std	std	std												
			std	std	std	std	std												
double guides																			
PPD79	ex		std	std	std	std	std		ex	std	std		odr	ldr	odr	ldr	odr		
PPD79/ODS	ex		std	std	std	std	std				std								
PPD79/ODS/20			std			std	std				std								
PPD079	ex		std	std	std	std	std				std								
PPDM079	ex		std			std	std		std	std	std			ldr		ldr			
grown up																			
N/PP66	ex		std	std		std	std			std	std								
N/PPD79	ex		std	std		std	std												
	ex		std	std		std	std			std									
distance																			
D/PP	ex		std	std	std	std	std			std	std		odr		odr		odr		
aluminum guides for the OPOTERM system																			
PPDAMW60/12			std			std					std								
PPDAMW-P60/12			std			std					std								
PPM060/12			std			std	std	std			std			ldr		ldr			
PPM060/17			std			std	std	std			std			ldr		ldr			
PPDA60/12			std			std													
PPDA60/17			std			std													

COLOR CODE		
KOD	280R	300R
PPDAMW60/12	odr	odr
PPDAMW-P60/12	odr	odr
PPDA60/12	odr	odr
PPDA60/17	odr	odr

*std – standard

*ldr – wood-like (lacquer)

*odr – wood-like (veneer)

*ex – extra

S – special color on request

PP53

for profile PA39, PA43

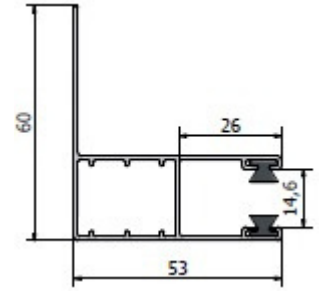
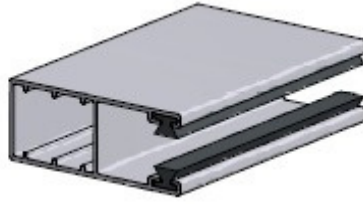
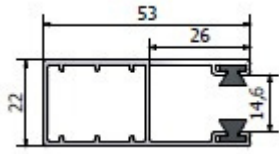

PP53/ODS

for profile PA39, PA43

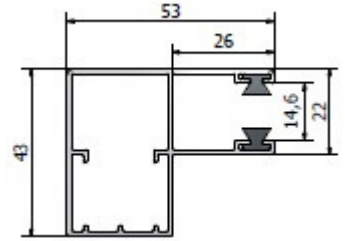
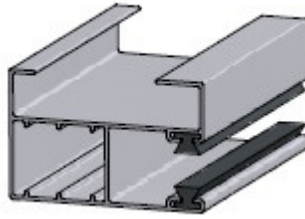
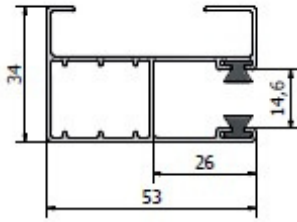

PPDO53

for profile PA39, PA43

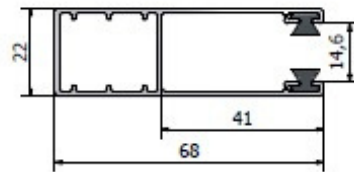
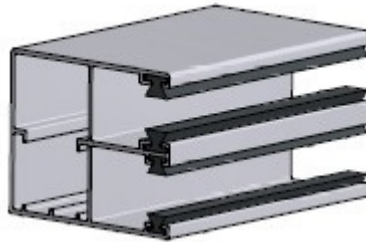
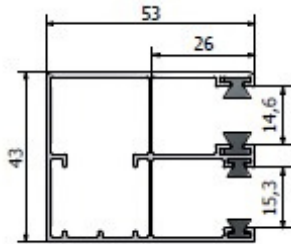

PPW66

for PE41 profile

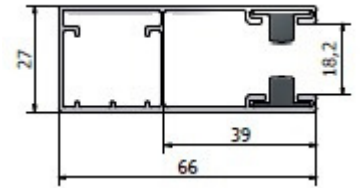
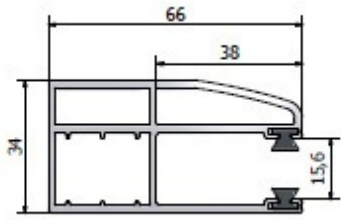

PP75

for profile PA52, PA55

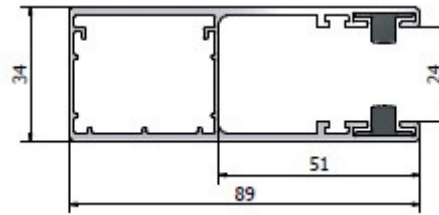
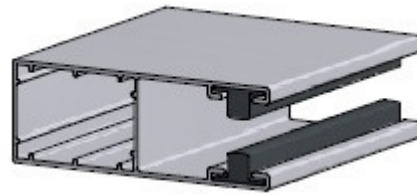
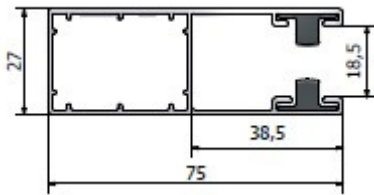

PP110

for profile PA77

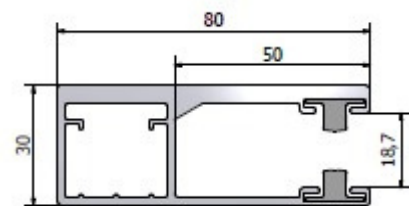
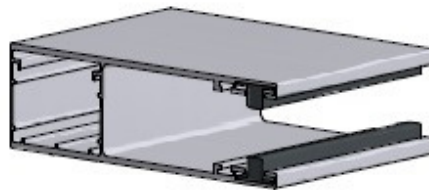
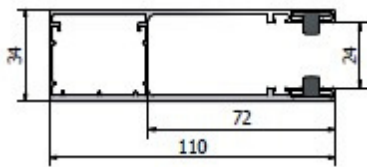

PPW90

for PE55 profile

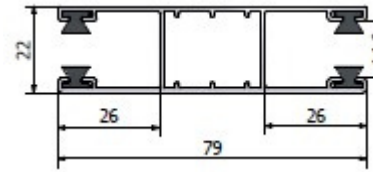
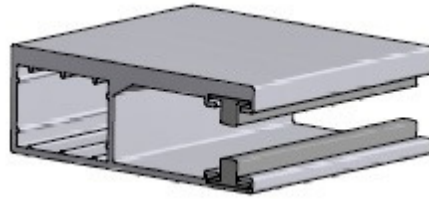
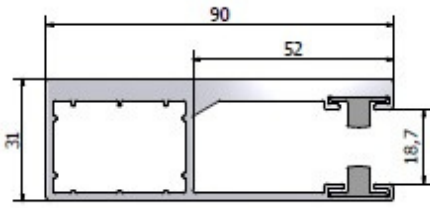

PPD79/ODS

for profile PA39, PA43

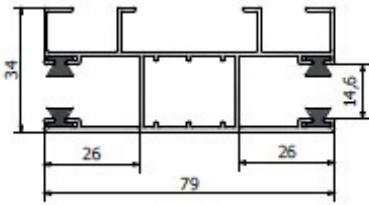

N/PPDO

used with PP53, PP53/ODS, PK53, PPD79, PPD79/ODS + PZO plate

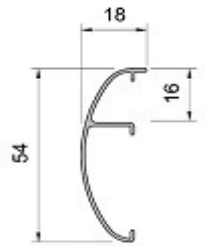

N/PPD79

used with PPD79, PPD79/ODS + PZO plate

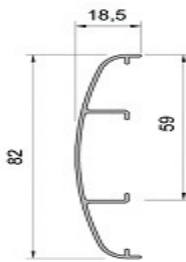

D/PP

used with PP53, PK53, PPD053 + PZO insert

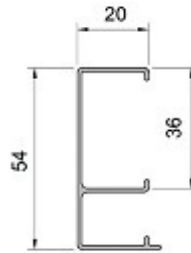

PP45
for profile PA39, PA43

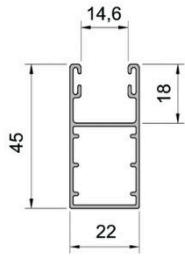

PU45
for profile PA52, PA55

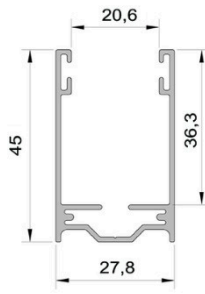

PP53/ODS/20
for profile PA39, PA43

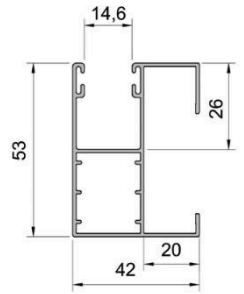

PPDMO79
for profile PA39, PA43

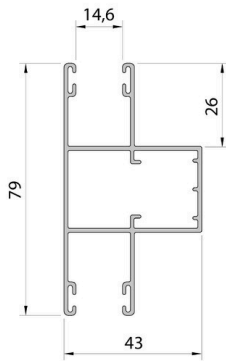

PPD79/ODS
for profile PA39, PA43

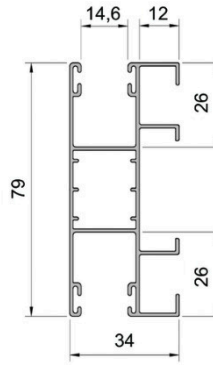

PPD79/ODS/20
for profile PA39, PA43

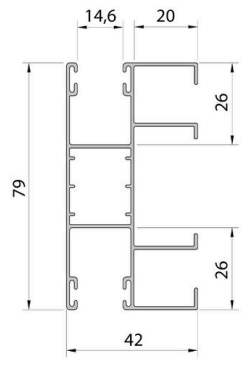

PPDA60/17
for profile PA52

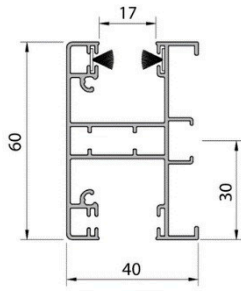

PPDAMW60/12
for profile PA39, PA43

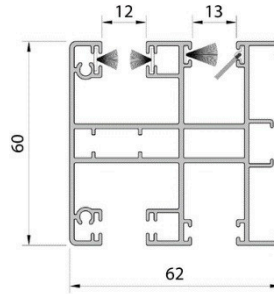

PPDAMW-P60/12
for profile PA39, PA43

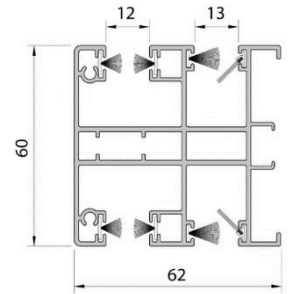

PPMO60/17
for profile PA52

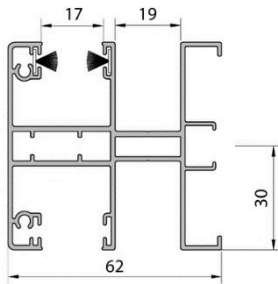

PVC guides

CODE	COLOR	FOIL NAME	FOIL CODE
02	White		
08	Brown		
26R	Gray		
Mahogany	anthracite	anthracite grey / anthracite	LG KDB74
		grey mahogany / mahogany	LG UR602
280R	Walnut	nut / nut golden oak / golden	9.21788007
300R	Golden Oak	oak winchester / winchester	9.2178001
52R	Winchester	dark oak / dark oak	9.0049240
53R	Dark Oak		9.2052089

PPD60/12

for profile PA39, PA43

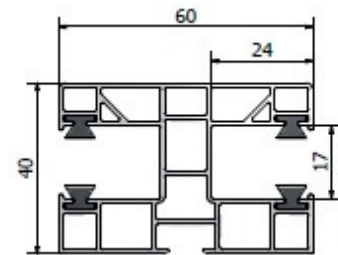
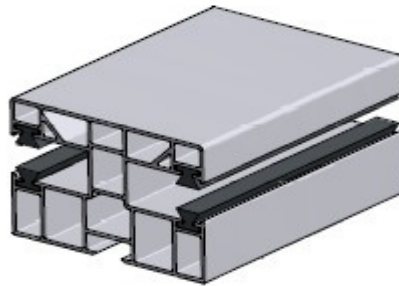
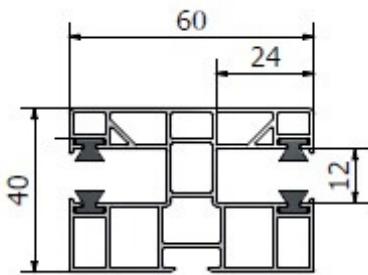

PPDM60/12

for profile PA39, PA43

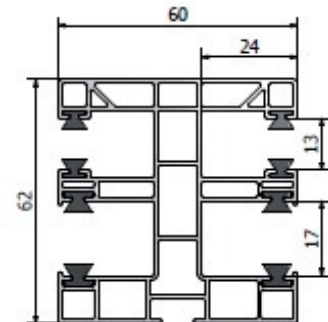
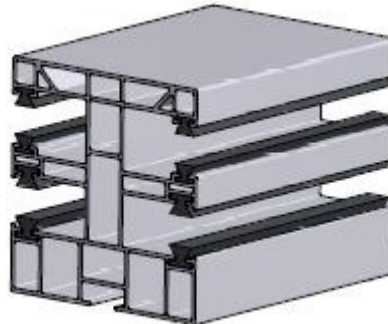
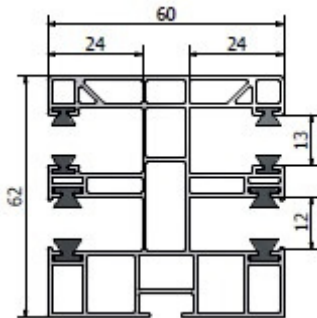

PPDMW60/12
for profile PA39, PA43

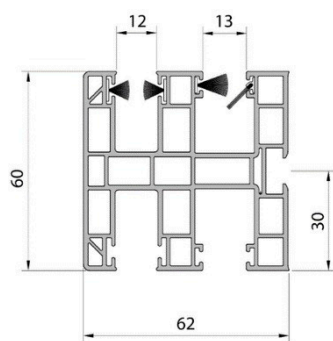

PPDMW-P60/12
for profile PA39, PA43

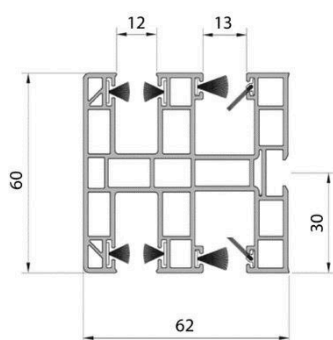

PP
fo

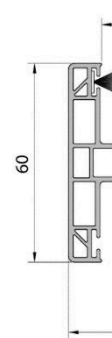

PPD
fo

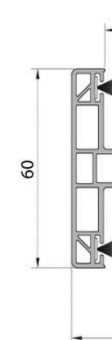

Winding of roller blinds

Profile PA39

Maximum height of the roller shutter with the box (mm)						
	SW40	SW40 + PZ/45	SW40 + PW/40	SW60	SW60 + PZ/68	SW60 + PW/60
SK/125	1240	1280	-	-	- 1210 2120	- - 1450 1930
SK/SKP/SP-E/137	1560	1600	-	1440	2630 3780	3400
SK/SKP/SP-E/165	2390	2470	2030	2280		
SK/SKP/SP-E/180	2950	3020	2520	2790		
SK/SKP/SP-E/205	4320	4210	3480	4050		

Maximum height of the roller shutter with the box (mm)						
	SW40	SW40 + PZ/45	SW40 + PW/40	SW60	SW60 + PZ/68	SW60 + PW/60
SHOES-P/137	1560	1600	-	1410	1250 2160	- 1450 2330
SHOES-P/165	2430	2510	2080	2320	2640 3820	3410
SHOES-P/180	3260	3100	2910	3060		
SHOES-P/205	4370	4250	3950	4130		

Maximum height of the roller shutter with the box (mm)						
	SW40	SW40 + PZ/45	SW40 + PW/40	SW60	SW60 + PZ/68	SW60 + PW/60
SKT/230/170	1890	1690	1220	1730	1570 3040	980 2310 4020
SKT/230/210	3230	3310	2860	3270	4420	
SKT/255/240	4460	4770	3940	4460		

Profile PA39 + MKT

Maximum height of the roller shutter with the box (mm)						
	SW40	SW40 + PZ/45	SW40 + PW/40	SW60	SW60 + PZ/68	SW60 + PW/60
SK/SKP/SP-E/165	1730	1690	1330	1600	1650 1850	1100 1540 2500
SK/SKP/SP-E/180	2440	2240	1780	2360	2500	
SK/SKP/SP-E/205	2500	2500	2500	2500		

Maximum height of the roller shutter with the box (mm)						
	SW40	SW40 + PZ/45	SW40 + PW/40	SW60	SW60 + PZ/68	SW60 + PW/60
SHOES-P/165	1650	1690	1300	1540	1340 2130	790 1550 2500
SHOES-P/180	2440	2480	2050	2280	2500	
SHOES-P/205	2500	2500	2500	2500		

Maximum height of the roller shutter with the box (mm)						
	SW40	SW40 + PZ/45	SW40 + PW/40	SW60	SW60 + PZ/68	SW60 + PW/60
SKT/230/170	1600	1460	-	1220	1260 1870	- - -
SKT/230/210	2490	2220	-	1980	2500	
SKT/255/240	2500	2500	-	2500		

Maximum height of the roller shutter with the box (mm)						
	SW40	SW40 + PZ/45	SW40 + PW/40	SW60	SW60 + PZ/68	SW60 + PW/60
SKT NOVA/230/170	1490	1550	870	1100	1140 2020	630 1350 2600
SKT NOVA/230/210	2450	2410	1900	2170	2600	
SKT NOVA/255/240	2600	2600	2600	2600		

Profile PA43

Maximum height of the roller shutter with the box (mm)						
	SW40	SW40 + PZ/45	SW40 + PW/40	SW60	SW60 + PZ/68	SW60 + PW/60
SK/125	----	970	-	-	- 930 2110	-- 1800 2280
SK/SKP/SP-E/137	-	1410	-	1150	2590 3630	3340
SK/SKP/SP-E/165		2500	1620	2320		
SK/SKP/SP-E/180		2980	2460	2800		
SK/SKP/SP-E/205		4020	3900	3850		

Maximum height of the roller shutter with the box (mm)						
	SW40	SW40 + PZ/45	SW40 + PW/40	SW60	SW60 + PZ/68	SW60 + PW/60
SHOES-P/137	----	1410	-	1150	980 2070 2590	- 1800 2330
SHOES-P/165		2500	1630	2320	3640	3520
SHOES-P/180		2980	2460	2800		
SHOES-P/205		4020	3910	3980		

Maximum height of the roller shutter with the box (mm)						
	SW40	SW40 + PZ/45	SW40 + PW/40	SW60	SW60 + PZ/68	SW60 + PW/60
SKT/230/170	--	1720	1460	1460	1590 3080	1240 2440
SKT/230/210	-	3120	3000	3250	4210	3930
SKT/255/240		4680	4110	4420		

Profile PA43 + MKT

Maximum height of the roller shutter with the box (mm)						
	SW40	SW40 + PZ/45	SW40 + PW/40	SW60	SW60 + PZ/68	SW60 + PW/60
SK/SKP/SP-E/165	---	1600	1190	1510	1330 2120	1020 1600 2500
SK/SKP/SP-E/180		2460	1810	1900	2500	
SK/SKP/SP-E/205		2500	2500	2500		

Maximum height of the roller shutter with the box (mm)						
	SW40	SW40 + PZ/45	SW40 + PW/40	SW60	SW60 + PZ/68	SW60 + PW/60
SHOES-P/165	---	1600	1190	1510	1130 2120	1020 1600 2500
SHOES-P/180		2460	1810	1900	2500	
SHOES-P/205		2500	2500	2500		

Maximum height of the roller shutter with the box (mm)						
	SW40	SW40 + PZ/45	SW40 + PW/40	SW60	SW60 + PZ/68	SW60 + PW/60
SKT/230/170	---	1460	-	1290	1250 1870	---
SKT/230/210		2300	-	2040	2500	
SKT/255/240		2500	-	2500		

Maximum height of the roller shutter with the box (mm)						
	SW40	SW40 + PZ/45	SW40 + PW/40	SW60	SW60 + PZ/68	SW60 + PW/60
SKT NOVA/230/170	---	1290	770	1070	900 2000 2600	560 1310 2600
SKT NOVA/230/210		2430	1910	2210		
SKT NOVA/255/240		2600	2600	2600		

PA52 profile

Maximum height of the roller shutter with the box (mm)			
	SW60	SW60 + PZ/68	SW60 + PW/60
SK/SKP/SP-E/137	900	580	- 1410 1480
SK/SKP/SP-E/165	1590	1380	2440
SK/SKP/SP-E/180	2060	1800	
SK/SKP/SP-E/205	2700	2330	

Maximum height of the roller shutter with the box (mm)			
	SW60	SW60 + PZ/68	SW60 + PW/60
SHOES-P/137	850	640	- 1410 1900
SHOES-P/165	1640	1380	2440
SHOES-P/180	2060	1860	
SHOES-P/205	2700	2390	

Maximum height of the roller shutter with the box (mm)			
	SW60	SW60 + PZ/68	SW60 + PW/60
SKT/230/170	1170	910	950 1970 2940
SKT/230/210	2280	2020	
SKT/255/240	3230	2870	

Profile PA52 + MKT

Maximum height of the roller shutter with the box (mm)			
	SW60	SW60 + PZ/68	SW60 + PW/60
SKT/230/170	910	700	- - -
SKT/230/210	1450	1450	
SKT/255/240	2450	2400	

Maximum height of the roller shutter with the box (mm)						
	SW40	SW40 + PZ/45	SW40 + PW/40	SW60	SW60 + PZ/68	SW60 + PW/60
SKT NOVA/230/170	- - -	-	-	550	550 1300 2600	550 1350 2360
SKT NOVA/230/210		-	-	1610		
SKT NOVA/255/240		-	-	2600		

PA55 profile

Maximum height of the roller shutter with the box (mm)			
	SW60	SW60 + PZ/68	SW60 + PW/60
SK/SKP/SP-E/137	-	-	- - 1170 1850
SK/SKP/SP-E/165	960	1070	
SK/SKP/SP-E/180	1400	1510	
SK/SKP/SP-E/205	1970	2020	

Maximum height of the roller shutter with the box (mm)			
	SW60	SW60 + PZ/68	SW60 + PW/60
SHOES-P/137	-	-	- - 1170 1910
SHOES-P/165	1010	1070	
SHOES-P/180	1400	1510	
SHOES-P/205	1910	2020	

Maximum height of the roller shutter with the box (mm)			
	SW60	SW60 + PZ/68	SW60 + PW/60
SKT/230/170	790	630	- 1420 2270
SKT/230/210	1580	1580	
SKT/255/240	2260	2370	

Solar sets contain a battery that can be installed inside or outside the box, in a place protected from direct weather conditions. If the batteries are installed inside the box, the winding capacity of the external roller shutter system changes and is similar to the values declared for roller shutters with an integrated roller mosquito net. Please verify the size of the box when configuring the product or increase it by one size if the battery is installed inside the roller shutter box.

Winding of extruded profiles

Profile PE41

Maximum height of the roller shutter with the box (mm)						
	SW40	SW40 + PZ/45	SW40 + PW/40	SW60	SW60 + PZ/68	SW60 + PW/60
SK/SKP/SP-E/137	----	1100	-	1060	1020 1400	- 1230 1480
SK/SKP/SP-E/165		1750	1650	1690	1850 2640	2700
SK/SKP/SP-E/180		2000	1900	2190		
SK/SKP/SP-E/205		2880	2420	3180		

Maximum height of the roller shutter with the box (mm)						
	SW40	SW40 + PZ/45	SW40 + PW/40	SW60	SW60 + PZ/68	SW60 + PW/60
SHOES-P/137	----	1100	-	960	650 1410 1860	- 1150 1570
SHOES-P/165		1610	1400	1530	2450	2500
SHOES-P/180		2030	1780	2150		
SHOES-P/205		3070	2790	2700		

PE55 profile

Maximum height of the roller shutter with the box (mm)						
	SW60	SW60 + PZ/68	SW60 + PW/60	SW70	SW70 + PZ/78	SW70 + PW/70 + PZ/710
SK/165 SK/180	1010	850	-	-	-	--- 2560 2500 4090 4480
SK//205	1080	1190	1220	-	-	
SK/250 SK/250	1800	1750	1800	-	-	
+ KBS SK/300	2650	2810	2940	2870	2810	
SK/300 + KBS	2650	2760	2780	2590	2650	
	4270	4320	4480	4380	4380	
	4930	4430	4640	4540	4540	

Winding of gate profiles

PA55 profile

Maximum height of the roller shutter with the box (mm)						
	SW60	SW60 + PZ/68	SW60 + PW/60	SW70	SW70 + PZ/78	SW70 + PW/70 + PZ/710
SK/250 SK/250	3140	3140	3110	3200	3250	2940 2830 4640 5000
+ KBS SK/300	3090	3090	3110	3030	3030	
SK/300 + KBS	4650	5000	4970	4820	5000	
	4980	5000	-	5000	5000	

Profile PA77

Maximum height of the roller shutter with the box		
	(mm) SW70 + PWA70 + WA70	SW70 + PWA70 + WB
SK/250 SK/250	1610	1790 1790 2760 3300
+ KBS SK/300	1610	
SK/300 + KBS	2460	
SK/350	3080	
	4920	-